

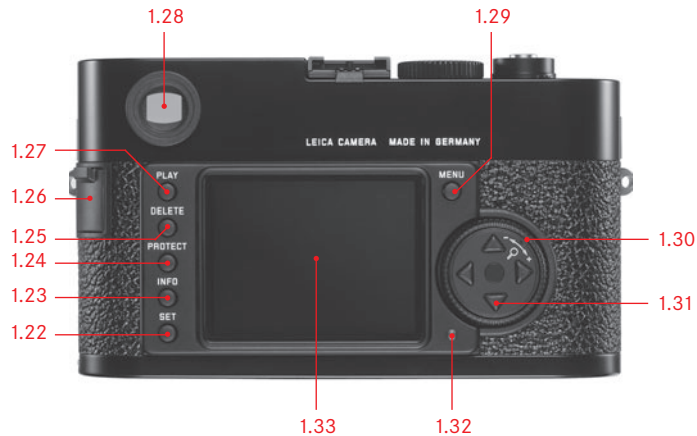

LEICA M8.2

Anleitung/Instructions

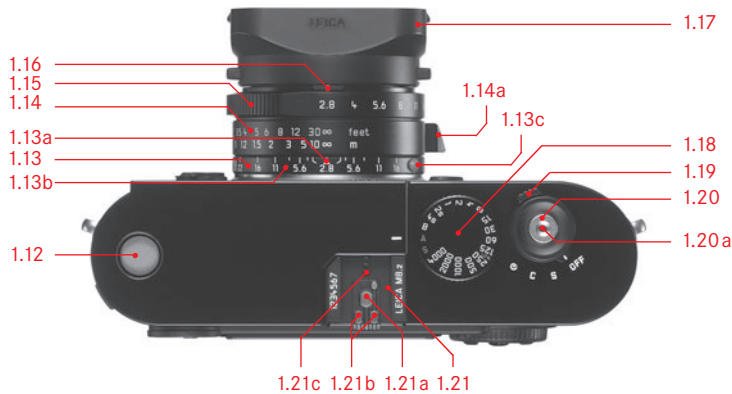

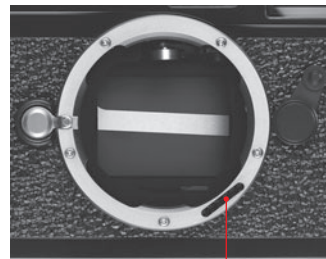
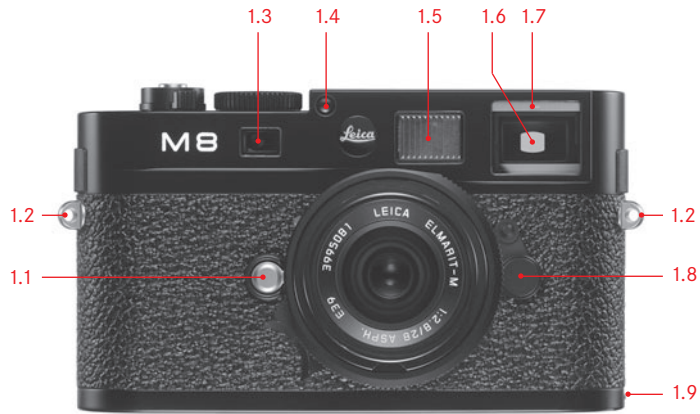
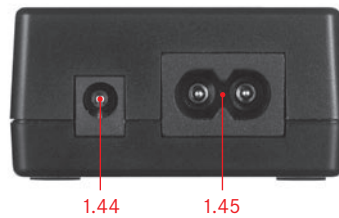
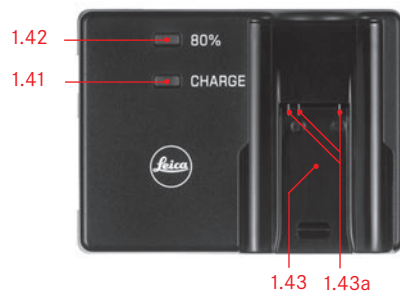



This is a Class B product based on the standard of the Voluntary Control Council for Interference from Information Technology Equipment (VCCI). If this is used near a radio or television receiver in a domestic environment, it may cause radio interference. Install and use the equipment according to the instruction manual.

FCC Note: (U.S. only)

This equipment has been tested and found to comply with the limits for a Class B digital device, pursuant to Part 15 of the FCC Rules. These limits are designed to provide reasonable protection against harmful interference in a residential installation. This equipment generates, uses, and can radiate radio frequency energy and, if not installed and used in accordance with the instructions, may cause harmful interference to radio communications. However, there is no guarantee that interference will not occur in a particular installation. If this equipment does cause harmful interference to radio or television reception, which can be determined by turning the equipment off and on, the user is encouraged to try to correct the interference by one or more of the following measures:

- Reorient or relocate the receiving antenna.
- Increase the separation between the equipment and receiver.
- Connect the equipment into an outlet on a circuit different from that to which the receiver is connected.
- Consult the dealer or an experienced radio/TV technician for help.

FCC Caution:

To assure continued compliance, follow the attached installation instructions and use only shielded interface cables with ferrite core when connecting to computer or peripheral devices.

Any changes or modifications not expressly approved by the party responsible for compliance could void the user's authority to operate this equipment.

Trade Name: LEICA
Model No.: LEICA M8.2
Responsible party/
Support contact: Leica Camera Inc.
1 Pearl Count, Unit A
Allendale, New Jersey 07401
Tel.: +1 201 995 0051 232
Fax: +1 201 995 1684
e-mail: olesin@aol.com

This device complies with Part 15 of the FCC Rules. Operation is subject to the following two conditions:
(1) This device may not cause harmful interference, and (2) this device must accept any interference received, including interference that may cause undesired operation.

This Class B digital apparatus complies with Canadian ICES-003

LEICA M8.2

 Tested To Comply
With FCC Standards

FOR HOME OR OFFICE USE

Foreword

Dear Customer,

Leica would like to thank you for purchasing the LEICA M8.2 and congratulate you on your choice. With this unique view and digital rangefinder camera, you have made an excellent selection.

We wish you a great deal of pleasure and success using your new LEICA M8.2.

In order to make best use of all the opportunities offered by this high performance camera, we recommend that you first of all read these instructions.

This manual has been printed on 100% chlorine free bleached paper. The complex manufacturing process eases the burden on the water system and thus helps to protect our environment.

Table of Contents

FCC notes	84
Foreword	85
Warning messages.....	88
Legal notes	88
Disposal of electrical and electronic equipment	88
Scope of delivery	89
Designation of parts	90
Displays	
In the viewfinder	92
In the top panel LCD	92
In the monitor	93
Menu items	
In the main menu	94
In the picture parameters menu	95
Snapshot mode S	96
Comprehensive instructions	
Preparations	
Attaching the carrying strap	98
Charging the battery	98
Inserting the battery into the camera /	
Removing the battery from the camera	100
Charge level displays	100
Inserting and removing the memory card	101

The most important settings / controls	
Leica M lenses	102
Using Leica UV/IR filters to correct color shifts for particular subjects and lighting situations.....	103
Switching the lens type identification on/off	103
Extension factor	105
Attaching a lens.....	105
Removing a lens	105
Switching the camera on and off/	
the main switch.....	106
Selecting picture taking and review modes.....	107
Review for unlimited time	107
Automatic review of last picture	107
Shutter release button	108
Serial exposures.....	109
Shutter speed dial	110
Monitor	111
Setting the brightness	111
Displaying the picture data.....	111
The histogram	112
Menu control.....	113
Main Menu	113
Picture parameters menu.....	113
Setting the menu functions.....	114
Presets	
Basics settings for the camera	
Menu language	116
Date and time	116
Automatic power off	117
Button acknowledgement and signal tones.....	117

Basic picture settings	
Resolution	118
Compression rate/file format	118
White balance	119
For automatic or fixed settings	119
For direct setting of color temperature	120
For manual setting by metering.....	120
ISO sensitivity	121
Image properties	
(contrast, sharpness, color saturation)	122
Working color space	123
Holding the camera correctly.....	123
Bright-line view and range finder.....	124
The frame selector	124
Distance metering.....	126
Superimposed image method (double image)	126
Split image method	126
Exposure metering	127
Turning the exposure meter on/off.....	127
Exposure modes	128
Aperture priority.....	128
Metering memory lock	128
Exposure compensation	129
Manual exposure setting	131
The B setting / the T-Function	131
Exposure meter metering range.....	132
Working below the metering range	132
Metering diagram.....	133

General information on flash exposure	Additional functions	Precautions and care instructions
metering and control 134	Changing the picture numbering 146	General precautions 153
Compatible flash units 134	Formatting the memory card 146	LCDs 154
Attaching the flash unit 135	Taking photographs with the self timer 147	Condensation 154
Flash mode 135	Transferring data to a computer 148	Care instructions
Settings for camera-controlled automatic	with Windows® XP / Vista® 148	For the camera 154
flash mode 136	with Mac® OS X (10.5) 149	For lenses 155
The flash lighting displays in the viewfinder	with card readers 149	For the battery 155
with system-compatible flash units 136	Data structure on the memory card 150	For the charger 155
In automatic flash mode 137	Working with DNG raw data 150	For memory cards 156
When the flash unit is set to camera	Installation of Capture One 4 150	Cleaning the sensor 156
control (A) or manual mode (M) 137	Installing firmware updates 151	Storage 157
Selecting the sync speed / the sync speed range ... 137	Miscellaneous	Warning messages 158
Selecting the firing moment 138	System accessories for the LEICA M8.2	Malfunions and their resolution 159
Additional functions	Exchangeable lenses 152	Index 160
User / application specific profiles 139	Filters 152	Technical data and descriptions 162
Resetting all custom settings 139	Universal Wide-Angle Viewfinder M 152	Leica Academy 165
Review mode 140	Viewfinder Magnifier M 1.25 x / 1.4 x 152	Leica on the Internet 165
Viewing other pictures / "Scrolling" in the memory.. 141	Handgrip M8 152	Leica information service 165
Enlarging / selecting the section /	Correction lenses 152	Leica customer service 165
simultaneous viewing of several	Cases 152	
reduced pictures 141	Spare parts 153	
Deleting pictures 143		
Protecting pictures /		
Clearing delete protection 144		

Warning messages

- You should use exclusively the recommended accessories to prevent faults, short circuits or electric shock.
- Do not expose the unit to moisture or rain.
- Do not attempt to remove parts of the body (covers); specialist repairs can be carried out only at authorized service centers.

Legal notes

- Please ensure that you observe copyright laws. The recording and publication of pre-recorded media such as tapes, CDs or other published or broadcast material may contravene copyright laws.
- This also applies to all of the software supplied.
- The SD logo is a registered trademark.
- Other names, company or product names referred to in this manual are trademarks or registered trademarks of the relevant companies.

Disposal of electrical and electronic equipment

(Applies within the EC, and for other European countries with segregated waste collection systems)



This device contains electrical and/or electronic components and should therefore not be disposed of in general household waste! Instead it should be disposed of at a recycling collection point provided by the local authority. This costs you nothing.

If the device itself contains exchangeable (rechargeable) batteries, these must be removed first and, if necessary, also be disposed of according to the relevant regulations.

Further information on this point is available at your local administration, your local waste collection company, or in the store where you purchased this device.

Scope of delivery

Before using your LEICA M8.2 for the first time, please check that the accessories supplied are complete.

- A. Battery
- B. Charger
- C. USB connecting lead
- D. Carrying strap
- E. DVD-ROM containing Capture One 4 from Phase One

Designation of parts

Front view

- 1.1 Lens release button
- 1.2 Eyelets for carrying strap
- 1.3 Distance meter viewing window
- 1.4 Brightness sensor¹
- 1.5 Illumination window for the bright-line frames
- 1.6 Viewfinder window with viewfinder displays reversed out for better clarity against bright backgrounds
- 1.7 Selftimer LED
- 1.8 Image field selector
- 1.9 Bottom cover locking clip

Front view of camera bayonet /rear view of lens bayonet

- 1.10 Sensor for lens identification
- 1.11 6-bit lens identification barcode

¹ Leica M lenses with viewfinder attachments cover the brightness sensor. Information about the use of these and other lenses can be found in the "Displays/In the viewfinder", p. 92 and "Leica M lenses", p. 102 sections.

Top view

- 1.12 LCD
- 1.13 Fixed ring with
 - a. Index for distance setting
 - b. Depth of focus scale and
 - c. Red index button for changing lenses
- 1.14 Focusing ring with
 - a. Recessed grip
- 1.15 Aperture setting ring
- 1.16 White index point for aperture setting
- 1.17 Lens hood
- 1.18 Shutter speed dial with
 - **A** detent position for automatic shutter speed control
 - **S** detent position for (snapshot) mode with extended automatic functions
- 1.19 Main switch with detent positions for
 - **OFF** (camera switched off)
 - **S** (single release)
 - **C** (continuous release)
 -  (self timer)
- 1.20 Shutter release button with
 - a. Tapped thread for cable release
- 1.21 Flash unit shoe with
 - a. Center (flash) and
 - b. Control contacts, and
 - c. Hole for retaining pin

Illustrations inside front and rear covers

Rear view

- 1.22 **SET** button for calling up the picture parameter menu / for calling up the sub-menu within the menu-driven commands / for loading settings/functions selected in the sub-menu
- 1.23 **INFO** button for displaying picture information during picture review
- 1.24 **PROTECT** button for selecting delete protection function
- 1.25 **DELETE** button for selecting delete function
- 1.26 USB port cover
- 1.27 **PLAY** button for switching on (continuous) review mode / for return to full picture display
- 1.28 Viewfinder window
- 1.29 **MENU** button for calling up and exiting the main menu
- 1.30 Central setting ring for navigation in menus / setting the selected menu items/functions, scrolling in the memory and for enlarging/reducing the pictures viewed
- 1.31 Direction buttons for navigation within the menus / for setting the selected menu items/functions and for scrolling through the memory
- 1.32 LED for indicating picture mode / recording data on to the card
- 1.33 Monitor

View with USB port cover open

- 1.34 USB port (5-pin, for connecting to computers)

Bottom view

(with bottom cover in place)

- 1.35 Tripod thread A ¼, DIN 4503 (¼").
- 1.36 Bottom cover
- 1.37 Locking toggle for bottom cover

(with bottom cover removed)

- 1.38 Battery compartment
- 1.39 Battery locking slider
- 1.40 Memory card slot

Charger

- 1.41 Green (**CHARGE**) LED to indicate charging
- 1.42 Yellow (**80%**) LED to indicate: 80% charge reached
- 1.43 Charging slot for battery with
 - a. Contacts
- 1.44 Socket for car charging cable
- 1.45 2-pin socket for
- 1.46 Replaceable mains cable

Displays

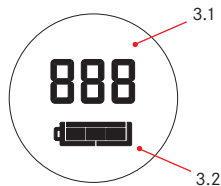
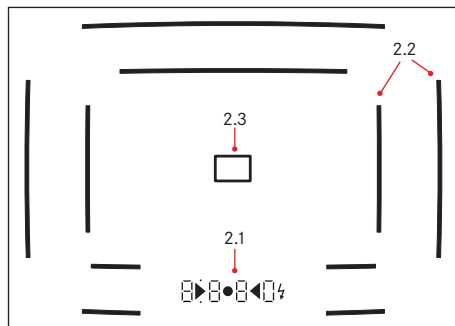
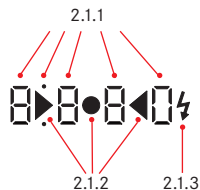

2. In the viewfinder

2.1 **LEDS** (Light Emitting Diodes)

(with automatic brightness control, which responds to the ambient brightness¹) for:

2.1.1. Four-digit seven-segment digital display with dots above and below

Digital display:

- Displays the automatically determined exposure time for aperture priority **A**, or for counting down exposure times longer than 1s
- Warning that the metering or setting ranges are overshoot or undershot using aperture priority **A**
- Displays the exposure compensation value (briefly during adjustment)
- Information that the buffer memory is (temporarily) full

Dot above:

- Information (when lit) that saved metering values are being used

Dot below:

- Information (flashing) that exposure compensation is being used

2.1.2 Two triangular and one circular LED:

- In the snapshot mode **S**: Circular LED displaying the correct exposure, plus right triangular LED to indicate possible overexposure or left triangular LED to indicate possible camera shake and/or underexposure
- For manual adjustment: Jointly used as light balance for exposure compensation
- Warning of values below the metering range

2.1.3 Flash symbol:

- Flash readiness
- Details of flash lighting before and after the exposure

2.2 Bright line frame for 24mm and 35mm (example)

2.3 Metering field for distance setting

3. In the top panel LCD

3.1 Number of pictures remaining

3.2 Battery status

¹ The automatic control is not available for Leica M lenses with viewfinder attachments, since they cover the brightness sensor 1.4 which supplies the information required for their operation. In such cases the displays always maintain a constant brightness.

4. In the monitor

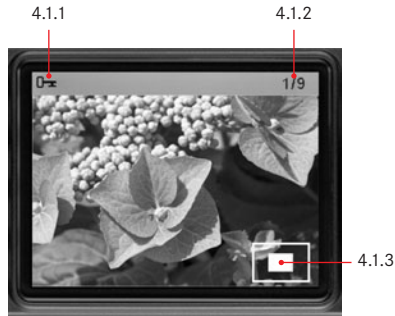

- 4.1 At normal review (image/s fill the entire monitor area)
 - 4.1.1 Delete protection symbol (only if set)
 - 4.1.2 Picture number / total number of available pictures
 - 4.1.3 Enlargement level or position of section shown (schematic, for enlarged view only)
 - 4.1.4 Selected picture (reduced viewing of 4 or 9 pictures only)

4.2 Reviewing with additional information

(INFO; reduced picture size)

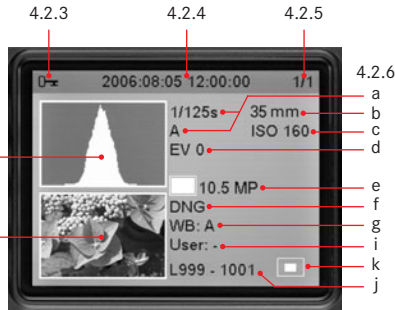

- 4.2.1 Picture (if necessary with "Clipping" display¹)
 - 4.2.2. Histogram
 - a. Luminance (brightness)
 - b. Red / green / blue (separate display of individual colors)
 - 4.2.3 Delete protection symbol (only if set)
 - 4.2.4 Date / time
 - 4.2.5 Picture number / total number of available pictures
 - 4.2.6 Picture information
 - a. Exposure modes and exposure time
 - b. Focal length²
 - c. Sensitivity
 - d. Exposure compensation
 - e. Resolution
 - f. Compression / file format
 - g. White balance
 - i. User profile number
 - j. Folder number / file name
 - k. Size and position of section (only if in use)

¹ see "Histogram", p. 112

² Only with the latest M lenses with 6-bit coding, or suitably converted lenses (see p. 102)

Menu items

Notes:

- In aperture priority and manual exposure control modes, both menus are available with all items except 5.1.25.
- In snapshot mode **S**, there is only a single menu. It includes only the items highlighted in grey; the others do not appear in S mode and are either fixed or not available.

5.1 In the main menu

	Menu item	Explanation	Fixed setting in snapshot mode S
5.1.1	Lens Detection	Lens type identification	On + UV/IR
5.1.2	Save User Profile	User-specific profile (save)	Not available
5.1.3	Self Timer	Self timer delay time	12 s
5.1.4	Auto ISO Setup	Automatic sensitivity control	AUTO ISO / Lens dependent
5.1.5	Sharpening	Picture sharpening	Standard
5.1.6	Color Saturation	Picture color saturation	Standard
5.1.7	Contrast	Picture contrast	Standard
5.1.8	Monitor Brightness		Standard
5.1.9	Histogram	Graphic to indicate distribution of brightness	Off
5.1.10	Picture Numbering		Continuously
5.1.11	Auto Review	Picture	5 seconds
5.1.12	Auto Power Off	Automatic power off	2 minutes
5.1.13	Flash Sync		1. Curtain
5.1.14	Auto Slow Sync	Flash shutter speed	Lens specific
5.1.15	Color Management	Working color space	sRGB
5.1.16	Reset	(To original factory settings)	Not available
5.1.17	Sensor Cleaning	Shutter opening for cleaning the sensor	Not available
5.1.18	Date		
5.1.19	Time		
5.1.20	Acoustic Signal	Button acknowledgement tone	Off
5.1.21	Language		
5.1.22	Format SD-Card	Formatting the memory card	
5.1.23	Firmware	Firmware version	Not available
5.1.24	Advance	Delay for cocking the shutter	Standard
5.1.25	Picture Settings	Color or B/W	

5.2 In the picture parameters menu

Menu item	Explanation	Fixed setting in snapshot mode S
5.2.1 ISO	Sensitivity	AUTO ISO
5.2.2 EV	Exposure compensation	±0 (=Off)
5.2.3 White Balance		Automatic
5.2.4 Compression	Compression rate/file format	JPG fine
5.2.5 Resolution		10 MP
5.2.6 User Profile	User-specific profile (recall)	Not available

Snapshot mode S

The LEICA M8.2 provides you with a mode that makes photography much easier and, at the same time, more reliable and faster. The only prerequisite is coded Leica M lenses (see page 102), particularly useful for short focal lengths up to 35 mm (see “Explanations”, section 1 below).

Setting the LEICA M8.2 to S mode with the shutter speed dial (1.18) and fitting a lens of this type reduces your work – except for the picture composition, e.g. choosing the trimming, you only have to make two settings, just once per lens or focal length (see “Explanations” section 2 below). The camera even helps you do this. Pressing the INFO button (1.23)

displays a graphical representation of the lens fitted in the monitor (1.33), with three items highlighted – the suggested aperture (a), the suggested distance (b), and the resulting depth of field (c, see “Explanations” section 3 below).

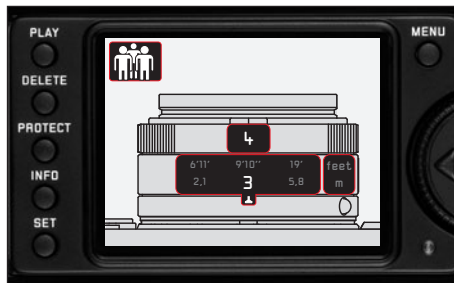

These two settings are the only “manual” actions and, when taking photographs with this lens or this focal length you do not need to make any other settings yourself – the camera does it all for you.

The depth of field resulting from the suggested settings – the distance range in which all parts of the subject are depicted sharply – is sufficiently large that in many situations and for the majority of subjects, you can expect sharp reproduction of the key elements of the picture.

The exposure for each shot is determined by the automatic shutter speed control (for more details see “Aperture priority”, p. 128). For this automatic control to work over a very wide brightness range – if necessary due to low brightness, the sensitivity is simultaneously, and also automatically, set to higher values (for more details see “ISO sensitivity, p. 121). On top of everything else, the camera warns you if your pictures could be out of focus due to camera shake (see “Explanations” section 4 below).

You only need to look at the display in the viewfinder.

If only the red circular LED in the center is lit (•), everything is fine.

If a red triangle to the right is also flashing (◀•), the automatic setting range has been exceeded due to excessive brightness and there is a risk of overexposure.

Even so, in the vast majority of cases you then have the opportunity to ensure that the correct exposure is used by setting a lower aperture value than the preset one (see above). To do this, turn the aperture setting

ring (1.15) in the direction indicated by the flashing triangle – to the left.

If a red triangle is also flashing to the left (◀), there is a risk of a blurred picture (see comment 4 below).

Even so, in the vast majority of cases you then have the opportunity to ensure a sharp, non-blurred picture by setting a higher aperture value than the preset one (see above). To do this, turn the aperture setting ring (1.15) in the direction indicated by the flashing triangle – to the right.

Even critical light situations with significant brightness/darkness differences can easily be dealt with. For example, in a portrait with backlight, if

- you want your main subject to be outside the center of the picture, and
 - its brightness simultaneously differs significantly from the rest of the subject, you can use metering memory lock.
1. Aim the center of the viewfinder at your main subject.
 2. Press the shutter release to its 2nd pressure point.
 - As long as you maintain the pressure point, the metered value is stored and a small red dot appears above the circular LED in the viewfinder as confirmation.
 3. Move the viewfinder back to your final trimming and
 4. release the shutter.

Further details of metering memory lock can be found in the corresponding section on p. 128.

All in all, the **S** mode represents a quick and carefree way of taking photographs, exceptionally well suited for snapshots and delivering an excellent success rate with minimal effort.

Explanations

1. Shorter focal lengths – in the wide angle range – result in relatively large depth of field ranges and are therefore better suited for snapshots from the outset. Longer focal lengths of above 50mm – normal and telephoto lenses – sometimes have significantly narrower depth of field ranges, which means that in practice taking photographs is rarely possible without precise focusing.
2. With the LEICA TRI-ELMAR-M 16-18-21mm f/4 ASPH. when changing the focal length the values displayed in the monitor must also be reset.
3. To match the relevant aperture, distance values are specified at which infinity is not set to the index in the center of the aperture scale, as is normal, but to the “long-range limit” of the relevant depth of field range, i.e. the right of the two indexes in the pair of values. Particularly with shorter focal lengths, the combination of these settings results in a significant enlargement of the usable depth of field into the close-up range.
4. As a rule of thumb: There is a risk of blurring with shutter speeds below the $\frac{1}{\text{focal length}}$ threshold, e.g. at slower speeds than $\frac{1}{30\text{s}}$ with a 28 mm lens.

Notes:

- Flash units can also be used in **S** mode. For more details, refer to the corresponding sections starting on p. 134.
- You can use the **Picture Settings** item in the menu (5.1.25) to specify whether you want to produce color pictures or classic black and white pictures. For details of the exact procedure in the menu, refer to the “Menu control” section on p. 113.

Comprehensive instructions

Preparations

Attaching the carrying strap

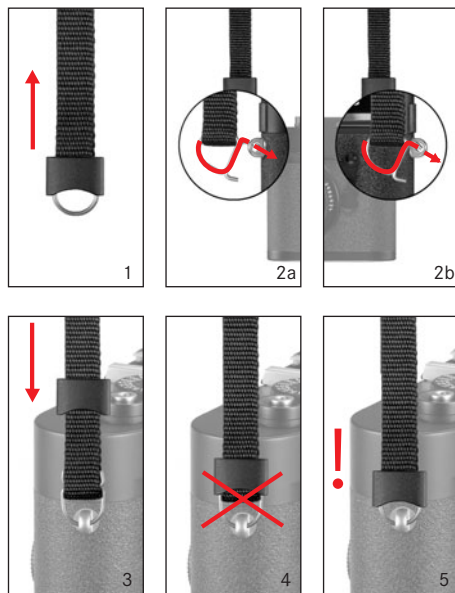

Charging the battery

The LEICA M8.2 is supplied with power by a Lithium ion battery (A).

Attention:

- Only the battery type specified and described in this manual, and/or battery types specified and described by Leica Camera AG, may be used in this camera.
- This battery may only be used in the units for which it is designed and may only be charged exactly as described below.
- Using this battery contrary to the instructions and using non-specified battery types can under certain circumstances result in an explosion.
- Never throw batteries into a fire as this can cause them to explode!
- Only the charger specified and described in this manual or the Leica charger order no. 14 463 is to be used.
The use of other chargers not approved by Leica Camera AG can cause damage to the batteries and, in extreme cases, to serious or life-threatening injuries.
- The charger supplied should be used exclusively for charging this battery type. Do not attempt to use it for other purposes.
- Ensure that the mains outlet used is freely accessible.
- The charger may not be opened. Repairs may only be carried out by authorized workshops.

Notes:

- The battery should be charged before the LEICA M8.2 is used for the first time.
- The battery must have a temperature of 0°-35°C to be charged (otherwise the charger will not switch on, or will switch off again).
- Lithium ion batteries can be charged at any time, regardless of their current charge level. If a battery is only partly discharged when charging starts, it is charged to full capacity faster.
- The batteries warm up during the charging process. This is normal and not a malfunction.
- If the two LEDs (1.41/1.42) flash quickly once charging has begun (>2Hz), this indicates a charging error.
In this case, disconnect the charger from the mains and remove the battery.
Ensure that the above temperature conditions are met and then restart the charging process.
If the problem persists, please contact your dealer, the Leica office in your country or Leica Camera AG.

- A new battery only reaches its full capacity after it has been fully charged and – by use in the camera – discharged again 2 or 3 times. This discharge procedure should be repeated every 25 cycles. To ensure a maximum service life of the battery, it should not be exposed to constant extremes of temperature (e.g. in a parked car in the summer or winter).
- Even with optimum conditions of use, every battery has a limited service life! After several hundred charging cycles, this becomes noticeable as the operating times get significantly shorter.
- Defective batteries should be disposed of in line with the applicable regulations (see p. 88).
- The replaceable battery provides power to a back-up battery which is built into the camera. This back-up battery maintains the reference data such as the date for up to 3 months. If this back-up battery becomes discharged it must be recharged by inserting the replaceable main battery. Once the replaceable battery has been inserted, the full capacity of the back-up battery is recovered after about 60 hours. This process does not require that the camera be switched on.

1. Connect the charger, i.e. plug the connector on the mains cable (1.46) into the corresponding socket on the charger (1.45) and connect the other end to a mains outlet.
2. Insert a battery with its contacts underneath and the end marked with an arrow facing forwards as far as it will go into the bay (1.43) on the charger. The shape of the bay ensures that the battery is positioned correctly.



- The green LED marked **CHARGE** (1.41) starts flashing to confirm that charging is in progress. As soon as the battery has charged to at least $\frac{4}{5}$ of its capacity, the yellow LED marked **80%** (1.42) also lights up. When the battery is fully charged, i.e. 100% capacity reached (after approx. 3 ½ hours), the green LED changes from flashing to continuously lit.

Note:

The **80%** LED lights up after around 2 hours due to the charging characteristics. This level of charge is enough to take around 400 pictures.

Therefore, if you do not need the full capacity of around 500 pictures, the camera is always ready to use again in a relatively short time.

3. The charger should then be disconnected from the mains. However, there is no risk of overcharging.
4. Remove the battery by pulling or sliding it back out of the bay (there is a recess on the front of the bay for this purpose).

Inserting / removing the battery in / from the camera

1. Set the main switch (1.19) to OFF.



2. Remove the bottom cover (1.36) of the camera. To do this:

- flip up toggle (1.37) in the bottom cover,
- turn it to the left, and
- lift off the bottom cover.



3. Insert the battery into the compartment with its contacts facing forwards. Press it into the compartment (1.38) until the white sprung locking catch (1.39) moves over the battery to hold it in place.

4. Replace the bottom cover To do this:
- insert it into the retaining clip (1.9) on the side of the camera
 - swing it down,
 - lock it by turning the toggle to the left as far as the stop, and
 - push the toggle back down.

To remove the battery, follow these instructions in reverse order. The white sprung locking catch in the battery compartment must be pushed to the side to unlock the battery.

Note:

Always switch the camera off before removing the battery.

A fully charged battery (to the CIPA standards) is sufficient for approx. 500 pictures each reviewed for 4s.

Charge level displays (3.2)

The charge level of the battery is displayed in five stages by the top panel LCD (1.12).

	: approx. 75-100 %
	: approx. 50-75 %
	: approx. 25-50 %
	: approx. 5-25 %
	: approx. 0-5 %, battery replacement or recharging necessary

Notes:

- Remove the battery if you will not be using the camera for a long period of time. When doing so, turn the camera off first using the main switch.
- After 3 months out of use, the back-up battery in the camera will be exhausted (see also the last note under “Charging the battery”, p. 98), and all individual settings will need to be made again.

Inserting and removing the memory card

The LEICA M8.2 saves the picture data on an extremely compact SD (secure digital) or SDHC (high capacity) card.

SD/SDHC memory cards are small, light and interchangeable external storage media. SD/SDHC memory cards, particularly those with a high capacity, allow significantly faster read/write times and significantly faster recording and review of the data. An SD card has a write protection switch, can be used to block unintentional storage and deletion of pictures. This switch takes the form of a slider on the non-beveled side of the card; in the lower position, marked LOCK, the data on the card is protected.

SD/SDHC memory cards are available from different suppliers and with different capacities and read/write speeds.

Note:

Do not touch the memory card contacts.

1. Set the main switch (1.19) to OFF.



2. Remove the bottom cover (1.36) of the camera. To do this:
 - a. flip up toggle (1.37) in the bottom cover,
 - b. turn it to the left as far as the stop, and
 - c. lift off the bottom cover.



3. Insert the memory card into the slot (1.40) with the contacts at the back and with the beveled corner pointing downwards. Slide it completely into the slot against the spring resistance until you hear it click into place.
4. Replace the bottom cover To do this:
 - a. insert it into the retaining clip (1.9) on the side of the camera
 - b. swing it down,
 - c. lock it by turning the toggle to the left as far as the stop, and
 - d. push the toggle back down.

To remove the memory card, switch off the camera and follow this procedure in reverse order. To release, the card must first be pressed slightly further in – as indicated on the camera bottom.

Notes:

- The range of SD/SDHC cards available is constantly changing; some cards may malfunction when used in the LEICA M8.2. Information on compatible cards can be found on our homepage at: http://en.leica-camera.com/service/downloads/rangefinder_cameras/m8.2
- If the memory card cannot be inserted, check that it is aligned correctly.
- If you remove the bottom cover or take out the memory card, the monitor displays the respective warning messages instead of the normal display:
 - Bottom cover removed
 - No memory card
- Do not open the bottom cover nor remove the memory card while the red LED (1.32) at the bottom right of the monitor (1.33) is flashing, indicating picture recording and/or data saving to the card. Otherwise the not yet (completely) saved picture data may be lost.
- As electromagnetic fields, electrostatic charges, and defects on the camera or the card can lead to damage or loss of the data on the memory card, we recommend that you also transfer the data to a computer and save it there (see p. 148).
- For the same reason, it is recommended that the card is always stored in its antistatic cover.

The most important settings / controls

Leica M lenses

Essentially, most Leica M lenses can be used with the LEICA M8.2. Details on the small number of exceptions and restrictions can be found in the following notes.

Usage is independent of the initial format of the respective camera – whether 18x27 mm (sensor size) for the digital Leica M8.2 or 24x36 mm for the 35mm models up to the LEICA M7, and also independent of the lens fitted – with or without 6-bit coding in the bayonet mount (for the latest version, see “Switching lens type identification on and off” on the next page).

Even without this additional feature, i.e. when using Leica M lenses without identification, the LEICA M8.2 will deliver excellent pictures in most situations.

Important:

• Cannot be used:

- Hologon 15mm f/8
- Summicron 50mm f/2 with close up
- Elmar 90mm f/4 with retractable tube (manufactured from 1954–1968)
- Some examples of the Summilux-M 35 mm f/4 (not aspherical, manufactured from 1961–1995, Made in Canada) cannot be attached to the LEICA M8.2 or will not focus to infinity. Leica Customer Service can modify these lenses so that they can be used on the LEICA M8.2.

• Can be used, but risks damaging the camera

Lenses with a retractable tube can only be used with their tubes extended, i.e. their tubes must never be retracted into the LEICA M8.2. This is not the case with the current Macro-Elmar-M 90 mm f/4, whose tube does not protrude into the camera body even when retracted. It can therefore be used without any restrictions.

• Can be used, but precise composition is not possible

The LEICA M8.2 has bright-line frames for focal lengths up to 90 mm (see p. 124). Therefore, when using longer focal lengths such as the 135mm models without a viewfinder attachment, their image field in the camera viewfinder – which is very small to start with – can only be “determined” very imprecisely.

• Can be used but are excluded from exposure metering

- Super-Angulon-M 21 mm f/4
- Super-Angulon-M 21 mm f/3.4
- Elmarit-M 28 mm f/2.8 with serial nos. earlier than 2 314 921.

Note:

Leica Customer Service can retrofit many Leica M lenses with 6-bit coding. Enquiries for specific cases to (address, see p. 165).

Using Leica UV/IR filters to correct color shifts for particular subjects and lighting situations

The use of CCD sensor such as in the LEICA M8.2 always results in a slight technology conflict. Sensors of this type have increased sensitivity to infrared light that is not visible to the human eye and, unless appropriate counter-measures are taken and in specific, rather rare situations, can consequently cause a slight but problematic color shift in pictures. This is particularly the case for fabrics made of black artificial fibers photographed under incandescent bulbs, i.e. artificial light. In such cases, without correction the black can be reproduced as something between purple and dark red.

The normal counter-measure, as on the LEICA M8.2, is to use an IR blocking filter directly in front of the sensor. However, each additional optical element between the lens and the image sensor reduces the performance of the entire system to a small but visible extent.

For this reason, Leica has deliberately used an exceptionally thin filter in the LEICA M8.2, which allows the outstanding performance of the Leica M lenses to be utilized to the full, at the expense of a slightly lower IR blocking effect.

To eliminate possible color shifts – without having to accept the associated disadvantages – Leica supplies UV/IR filters (see “Filters”, p. 152), which are screwed on in front of the relevant lens. In addition to the information that coded Leica M lenses (see next section) transfer to the camera, the camera then automatically corrects any remaining color shift for the specific lens fitted. As a result, you obtain pictures with the impressive sharpness and contrast typical of Leica M lenses and totally realistic color reproduction.

Switching lens type identification on and off

The 6-bit coding in the bayonet mount (1.11) of current Leica M lenses allows the LEICA M8.2 to recognize the type of lens fitted using the sensor in its bayonet (1.10).

- Among other things, this information is used to optimize the picture data. Thus edge darkening which can be particularly noticeable with wide-angle lenses and large apertures can be compensated in the respective picture data.
- With wide angle lenses from 16 to 35mm and when using Leica UV/IR filters (see previous section) the camera automatically corrects the color gradient to the edge of the picture for the specific focal length.
- The control of flash lighting and the flash reflector also uses the lens data (see “Compatible flash units”, p. 134).
- In addition the information carried by this 6-bit coding is written to the respective EXIF file for the picture. The picture data shown in the **INFO*** display (see “The monitor”, p. 111) also shows the lens focal length (4.2.6 b, see p. 93).

* Not available in snapshot mode S



Note:

When using aperture priority and manual exposure setting in conjunction with a lens without 6-bit coding, the camera's identification function must always be turned off, to prevent malfunctions.

Setting the function

1. In the main menu (see p. 94/113), select **Lens Detection** (5.1.1) and

With all Leica M lenses except the LEICA TRI-ELMAR-M 16-18-21 mm f/4 ASPH.

2. in the respective sub-menu, select the desired option.

Additional menu settings required for the LEICA TRI-ELMAR-M 16-18-21 mm f/4 ASPH.

With this lens, the set focal length is not transferred to the camera, meaning that it must be set using the menu:

2. In the sub-menu, select **On + UV/IR**. A new monitor screen appears with the title **Lens Identification Tri-Elmar + UV/IR**.

Note:

Provided **On + UV/IR** has previously been set, this monitor screen appears automatically as soon as the camera is turned on and/or the LEICA TRI-ELMAR-M 16-18-21 mm f/4 ASPH. is attached, regardless of whether or not the monitor was previously active.

3. In the box with a red outline, the three focal lengths 16, 18, and 21 mm can be selected using the direction buttons and/or the central adjusting dial and confirmed as normal with the SET button.

Notes:

- The setting in the menu must be made every time the focal length on the lens is changed.
- When the lens is attached, the middle focal length of 18mm is always preselected.
- This manual adjustment of the focal length in the menu is only necessary with the LEICA TRI-ELMAR-M 16-18-21 mm f/4 ASPH.. The LEICA TRI-ELMAR-M 28-35-50 mm f/4 ASPH. features the necessary mechanical transfer of the set focal length to the camera to display the appropriate bright-line frame in the viewfinder. The camera electronics detect the setting and use it to perform focal length specific correction.

Extension factor

The nominal focal lengths of the Leica M lenses are based on the 35mm film format, i.e. an initial format of 24x36mm. However, the sensor on the LEICA M8.2 is somewhat smaller, at 18x27mm, by a factor of 0.75. Therefore these lenses' angle of view on the LEICA M8.2 always corresponds to that for lenses with focal lengths longer by a factor of 1.33 (1.33 = reciprocal of 0.75). This has the corresponding effect on their perspective, but not on their depth of field which, with the LEICA M8.2, can also be read directly off the lens (see the lens instructions for more details).

Of course, the bright-line frame in the viewfinder of the LEICA M8.2 always shows the "correct" field of view for this camera, i.e. it takes account of the increased focal length. You can therefore compose your pictures in the normal way, just as for other cameras in the Leica M series (see also "The Leica bright-line view and range finder", p. 124).

Attaching a lens



1. Hold the lens by the fixed ring (1.13).
2. Align the red index button (1.13c) on the lens with the unlocking button (1.1) on the camera body.
3. Then push the lens straight on in this position.
4. Turn the lens slightly to the right, and you will hear and feel it click into place.

Removing a lens



1. Hold the lens by the fixed ring (1.13).
2. Press down the unlocking button (1.1) on the camera body.
3. Turn the lens to the left until its red index button (1.13c) is aligned with the unlocking button.
4. Then pull the lens straight off.

Notes:

- To protect the LEICA M8.2 against ingress of dust etc. into the interior of the camera, it is important always to have a lens or a cover fitted to the camera body.
- For the same reason, when changing lenses work without delay and in an environment that is as dust-free as possible.

Switching the camera on and off/the main switch

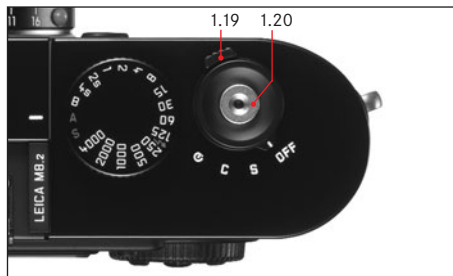

The LEICA M8.2 is turned on and off using the main switch (1.19). This is below the shutter release button (1.20) and is a lever with four detent positions:

a. OFF – Camera switched off

This is the inactive position – the camera is switched off.

b. S – Single release

Pressing the shutter release button (see below) takes only one picture, irrespective of how long it is kept pressed.

To ensure discreet operation, you can activate the **Discreet** function (see p. 109) in the menu (see p. 94/113).

c. C – Continuous release

Pressing the shutter release button (see below) takes up to 10 pictures in succession – as long as the capacity of the memory card being used and the camera's internal buffer memory are sufficient (see "Inserting and removing the memory card", p. 101).

d. – Self timer

Pressing the shutter release button (see below) starts the pre-set delay time (see p. 147), after which a picture is taken.

Switching on

After switching on, i.e. selecting one of the three functions **S**, **C** or , the LED (1.32) lights up briefly and the displays in the viewfinder (2.1.1) and in the top panel LCD (1.12) appear (see p. 92).

Note:

After switching on, the camera is ready to use after approx. 2s.

Switching off

Even if the main switch is not set to **OFF**, the camera is automatically switched off if automatic power off has been set in the menu (**Auto Power Off**, 5.1.12, see p. 113/117) and none of the functions are used during this time.

Note:

When transporting the camera, e.g. in a case, and if the camera will not be used for a long time, it should be turned off at the main switch.

Selecting picture taking and review modes

After switching on, the LEICA M8.2 is always in recording mode, i.e. the monitor (1.33) remains dark – once it is ready to use (see p. 106).

To review the pictures, you can choose between two modes:

1. **PLAY** Review for unlimited time
2. **Auto. Review** Brief review after taking the picture

Review for unlimited time - PLAY

By pressing the **PLAY** button (1.27) you can switch to review mode.

- The last picture taken appears in the monitor along with the corresponding displays (see p. 93). However, if the memory card inserted does not contain any image files, the following message appears when you switch to review mode:
No valid image to play.

Automatic review of the last picture - Auto Review

In **Auto Review** mode each picture is shown in the monitor (1.33) immediately after it has been taken. This allows you to quickly and easily check whether the picture was successful or needs to be taken again.

This function permits

1. selection of the duration for which the picture is displayed, and
2. review of the picture data, with or without histogram (see p. 112).

Setting the function

1. In the main menu (see p. 94/113) select **Auto Review** (5.1.11),
2. in the respective sub-menu first select **Duration**, and
3. in the further sub-menu that appears select the desired function or duration: (**Off**, **1 Second**, **3 Seconds**, **5 Seconds**, **Hold**).
4. To select whether the picture appears with or without a histogram (see p. 112), call up the first sub-menu again,
5. select **Histogram**,
6. and select the desired option (**On**, **Off**).

From **Auto Review** mode, you can switch back at any time to normal, i.e. unlimited, **PLAY** review mode (see above).

Note:

If you are taking photographs using the serial release function (see p. 109), the last picture in the series is shown first in either review mode. Details of how to select the other pictures in the series and further options in the review modes are described in the sections under “Review mode” starting on p. 140.

Shutter release button



The shutter release button (1.20) has three pressure points:

1. Briefly pressing to the first pressure point activates the exposure metering and viewfinder displays, and starts a pre-set self timer delay time, if this has been programmed (see p. 147).

If the shutter release button is let go, the metering system and the displays remain activated for around a further 12s (for more details, refer to the sections under “Exposure metering” on p. 127).

If the shutter release button is kept at this pressure point, the displays remain shown, or if the camera had previously been set to review mode (see p. 140), it switches back into recording mode. If the camera had previously been in stand-by mode (see p. 106), it will be reactivated and the displays switched on.

While the shutter release is held in this position, you can use the adjusting dial to quickly and easily set an exposure compensation (for more details, refer to the “Exposure compensation” section on p. 129).

Note:

The shutter release is locked

- if the internal buffer memory is (temporarily) full, e.g. after a series of up to 10 pictures,
- if the memory card in use is full and the internal buffer memory is (temporarily) full, or
- if no memory card is inserted and the internal buffer memory is full.

2. Pressing through to the second pressure point locks the exposure metering value in aperture priority mode, i.e. the shutter speed determined by the camera (for more details, refer to the “Metering memory lock” section on p. 128). After the shutter release button has been let go a new metered value can be determined.
3. If the shutter release is pushed fully down, a picture is taken. The data is then sent to the memory card.

In situations that call for a maximum amount of discretion, it can be beneficial to suppress the noise of cocking the shutter, at least temporarily. For this purpose – and exclusively in single release mode (main switch 1.19 in **S** position) – the **Discreet** option can be activated for the **Advance** item in the menu (5.1.24, see p. 94/113).

The shutter is then cocked when you release the shutter release button rather than immediately after taking the picture. The delay time – which can be of any length – can be used to move the camera to a place with sound insulation (under clothing or similar) or to wait for a more appropriate moment to cock the shutter.

Notes:

- Even if review mode (see “Selecting picture and review modes”, p. 107) or menu control (see p. 113) had been activated, pressing the shutter release button immediately switches the camera to recording mode.
- Menu control allows button acknowledgement (response) tones to be selected and set (see p. 117).
- To avoid camera shake, the shutter release button should be pressed gently – not jerkily, until the shutter is released with a soft click.

The shutter release button has a standard thread for a cable release.

Note:

With cable release the second pressure point is not perceptible.

Serial exposures

Thanks to the integrated motor for the shutter action, the LEICA M8.2 can be used not only for single exposures – main switch 1.19 set to (**S** [single]), but also for series of exposures – main switch set to (**C** [continuous]) – for example to capture sequences of movement in several stages.

Apart from the operation of the shutter release button (1.20), series of pictures are taken in the same way as single pictures: As long as you hold down the shutter release button (provided that the memory card has sufficient capacity), a series of pictures is taken. If however you only press the shutter release button briefly, this will again result in a single picture.

Pictures can be taken at a maximum of about 2 pictures a second and up to 10 in succession. For detailed information on the total possible numbers of pictures, refer to the table on p. 118.

Note:

Regardless of how many pictures have been taken in a series, the **PLAY** and **Auto Review** (5.1.11, see p. 107) functions initially always show the last picture.

Shutter speed dial

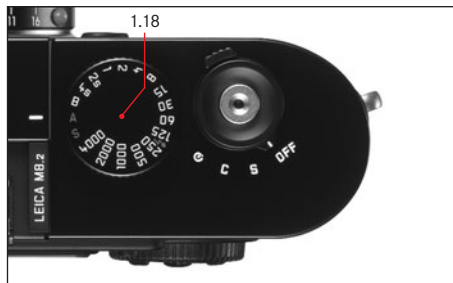

The size and position of the shutter speed dial (1.18) on the LEICA M8.2 are ergonomically optimized: On the one hand – even with the camera to the eye – it is very easy to use. On the other hand it is well protected against unintentional setting.

In addition its direction of rotation (like that of the aperture setting ring on the lenses) corresponds to the exposure meter displays in the viewfinder for manual adjustment: If for example the left-hand triangular LED lights up, rotation in the direction of the arrow, i.e. to the right, leads to the required longer shutter speed.

The LEICA M8.2 shutter speed setting dial is used to select the three exposure control modes,

- Aperture priority mode by setting the **A** position, marked red (see p. 128),
- Snapshot mode by setting the **S** position, marked red (see p. 96),
- Manual mode by selecting shutter speeds from $1/4000$ s to 6 s, (intermediate values in $1/2$ step graduations are also available, see p. 131)

as are

- the shortest possible sync time of $1/180$ s for flash mode, marked with the  symbol (see p. 134), and
- **B** for long exposures (see p. 131).

The LEICA M8.2 shutter speed setting dial has no stop, i.e. it can be turned in either direction from any position. It detents at all marked positions and at the intermediate values. Values between the detent positions cannot be used.

Notes:

- As described in connection with the ISO settings on p. 123, when using higher sensitivities and in particular with dark, even surfaces, a certain amount of noise will become apparent. To reduce this annoying phenomenon, following exposures with slower shutter speeds (approx. below $1/30$ s, differing depending on menu settings) the LEICA M8.2 automatically takes a second “black picture” (taken with the shutter closed). The noise present in this parallel picture is then digitally “subtracted” from the data set for the real picture.
- This doubling of the “exposure” time can be significant in particular at longer shutter speeds, and must be allowed for. During this time the camera should not be switched off.
- For shutter speeds of 2s or more the message **Noise reduction in progress 12s*** appears in the monitor.
- If the **B** function is selected in conjunction with the self timer (see p. 147), the shutter release button does not need to be kept pressed; the shutter will remain open until the shutter release button is pressed a second time (this is then equivalent to a T function).

More details on setting the correct exposure can be found in the sections under: “Exposure metering” from p. 127.

* Time quoted is an example only

The Monitor

The LEICA M8.2 has a large 2.5" liquid crystal color monitor (1.33). This is used for viewing pictures that have been saved to the memory card. It reproduces the entire image plus the selected data and information (see "Displays / In the monitor", p. 93, and "Displaying the picture data", on this page).



The monitor is protected by an exceptionally hard and scratch-resistant sapphire glass cover*, ensuring that your pictures are reproduced perfectly and with no problems even after years of use.

Note:

Most digital system cameras – as distinct from digital compact cameras – employ sensors that cannot show a preview picture, since the data can be read only picture by picture and not permanently.

Monitor pictures are therefore only available in review mode (see p. 140), and must be switched on using the **PLAY** button (1.27) or, if the **Auto Review** function (see p. 107) is activated, are displayed automatically.

To allow undistracted viewing, in the default setting only the following information is displayed (i.e. if additional information has not been selected using the **INFO** button (see p. 93):

1. in the header line, only the picture number (4.1.2), and
2. for deletion-protected pictures (see p. 145) the information symbol (4.1.1, ) ,
3. for enlarged or displaced review, in addition at the bottom right a symbol (4.1.3, ) , that shows – roughly – the position and size of the section.

Setting the brightness

The brightness of the monitor picture can be adjusted to five different levels using the menu control, so that you can select the optimum brightness for any situation, i.e. the ambient lighting conditions.

Setting the functions

1. In the main menu (see p. 94/113), select **Monitor Brightness** (5.1.8) and
2. in the sub-menu select which of the five levels you want to use (**low, medium low, standard, medium high, high**).

Displaying the picture data

The **INFO** button (1.23) allows you to select a whole range of additional picture data (see p. 11) together with a reduced picture size.

With menu control (**Histogram** 5.1.9, see p. 94/113) you can also select various histogram options (see next section).

Note:

When using snapshot mode **S**, the **INFO** button is used exclusively to display the suggested lens settings (see p. 96).

* Only diamonds and a few other materials are harder than sapphire and can thus cause scratches.

The histogram

The histogram (4.2.2) depicts the brightness distribution in the picture. The horizontal axis shows the tone values from black (left) through grey to white (right). The vertical axis depicts the number of pixels of each brightness level. This form of presentation – together with the impressing of the picture itself – permits an additional quick and easy assessment of the exposure setting after taking the picture.

The LEICA M8.2 allows you to choose between four versions of the histogram: Based on either the overall brightness or separately for the three primary colors red/green/blue, optionally with or without identification (red) of the areas in the picture where no image appears because they are too bright (clipping).

Note:

The histogram display always refers to the section of the picture displayed at that time.

A



A: Predominance of dark pixels, only few bright ones: Underexposure

B: Most pixels are of medium brightness: correct exposure

C: Predominance of bright pixels, only few dark ones: overexposed

B



C



Setting the function

1. In the main menu (see p. 94/113), select **Histogram** (5.1.9) and
2. in the associated sub-menu select the desired function: (**Std. w/o Clipping**, **Std. with Clipping**, **RGB w/o. Clipping**, **RGB with Clipping**).

Note:

The histogram is not available when simultaneously viewing several reduced pictures (see p. 141).

Menu control

Many settings for the LEICA M8.2 are controlled using menus (see p. 94/95).

When using snapshot mode **S** (see p. 96), there is only one menu – the main menu – with just 5 options. These mainly relate to basic settings (5.1.18/.19/.21/.22), which only need to be entered once, while all other relevant parameters are specified for ease of use. An additional option (5.1.25) can also be used to select whether color or black and white pictures are taken.

In aperture priority and manual exposure modes, two independent menus are available. In this case, the main menu contains 24 items (5.1.1-24) and there is also a picture parameter menu. Based on experience, the menu items are grouped and separated according to which are used most frequently, allowing them to be called up and set quickly and easily.

Note:

The setting operations for the individual menu items described in this manual normally relate to operation in aperture priority and manual exposure mode. In snapshot mode **S**, the options for most menu items are replaced with fixed settings, i.e. not editable by the user (see the list in the “Menu items” section, page 94/95).

Main menu

In aperture priority and manual exposure modes, in addition to the basic camera settings the main menu also includes storing user profiles and additional functions.

Picture parameters menu

The picture parameters menu comprises 6 items (5.2.1-.6, see p. 95), i.e. the basic settings for taking pictures and selecting the saved user profiles.

When the camera is switched on, an overview of the respective settings and step-by-step instructions for setting these functions can be viewed in the monitor. Settings are made in the same way in both menus, differing only in how they are accessed and exited.

Setting the menu functions

1. Call up the main menu using the **MENU** button (1.29); call up the picture parameters menu using the **SET** button (1.22).
 - The first 8 items then appear in the main menu (or all 5 in snapshot mode **S**) and all items in the picture parameters menu.

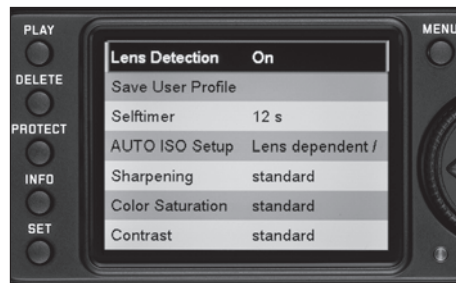

Notes:

- The picture parameters menu is
 - only accessible in recording mode (see p. 106), and
 - only available when using aperture priority (see p. 128) and manual (see p. 131) exposure modes. In snapshot mode **S**, the **SET** button has no function.
- If the **DELETE** or **PROTECT** functions are activated (see p. 143/144), the main menu cannot be accessed.

2. You can select the desired menu item either by turning the setting ring (1.30) or by pressing the up/down direction key (1.31).

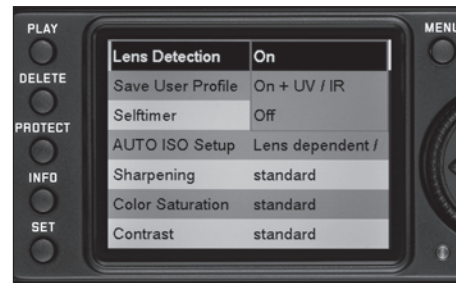



- To set the respective function first press the **SET** button (in the picture parameters menu, press it again).
 - The associated multi-line sub-menu, identified by a red outline, appears to the right of the menu item. The item selected is highlighted for identification.
- You can then select the desired function option either by turning the setting ring or by pressing the up/down direction buttons.
- Save your setting by pressing the **SET** button once again.
 - The function variation set is then shown to the right of the menu line.

- Exit the main menu by pressing the **MENU** button again; exit the picture parameters menu by
 - pressing the shutter release button (1.20 - if you want to switch to recording, mode),
or
 - pressing the **PLAY** button (1.27 - to switch to review mode).

Notes:

- In the main menu, you can exit a sub-menu at any time without applying any settings you have made in them by pressing the **MENU** button.
- By pressing the shutter release button (1.20) you can exit either menu at any time and switch directly to picture mode; by pressing the **PLAY** button (1.27) you can switch to review mode (see also “Selecting picture taking and review modes”, p. 107).

Menu items such as **Date** (5.1.18) and **Time** (5.1.19), and the **White Balance** function (5.2.3) require further settings. The corresponding explanations, as well as further details about the other menu functions, can be found in the relevant sections.

Presets

Basic settings for the camera

Menu language

By factory default, the language used for menu control is English, i.e. all menu items initially appear with their English names. German, French, Spanish, Italian, Japanese, and Chinese can all be selected as alternative menu languages.

Setting the function

1. In the main menu (see p. 94 / 113), select **Language** (5.1.21) and
2. in the respective sub-menu, select the desired language.
 - Apart from a few exceptions (button names, short designations), all linguistic information changes.

Date and time

The date and time are each set using separate menu items.

Date

There are 3 variations available for the sequence of the date.

Setting

1. In the main menu (see p. 94 / 113), select **Date** (5.1.18) and
2. call up the sub-menu. It consists of the 2 items, **Setting** and **Sequence**.
3. **Select Setting**.
 - A further sub-menu appears, containing groups of figures for the year, month and day, in which the currently active group, i.e. the one that can be set, is identified by a black background and red border.
4. The figures are set using the central setting ring (1.30) or the up and down direction buttons (1.31), while the left and right direction buttons are used to switch between the groups of figures.

Notes:

- Using the setting ring is normally not only more convenient but also significantly faster.
 - By pressing the **MENU** button (1.29) you can return to the main menu at any time – without applying any changes you may have selected in the sub-menu.
5. After setting all 3 values, confirm and save by pressing the **SET** button (1.22).
 - The list of menu items appears again.
 6. To change the way in which the figures are displayed, select **Sequence** in the sub-menu.
 - The three available sequences **Day/Month/Year**, **Month/Day/Year**, and **Year/Month/Day** appear.
 7. The preferred option is set and confirmed as described in points 3 and 4.

Note:

Even when no battery is inserted in the camera or the battery is flat, the date and time settings are maintained by a built-in back-up battery for about 3 months (see also “Charge level displays”, p. 100). However, after that time the date and time must be set again as described above.

Time

The time can either be shown in 24-hour or 12-hour format.

Setting

Both the two groups of figures and the display format are set under the **Time** menu item (5.1.19) using the **Setting** and **View** sub-items, essentially as described for the **Date**.

Automatic power off

This function switches the LEICA M8.2 off automatically after a pre-set time. This action is equivalent to setting the main switch to **OFF** (1.19, see p. 106).

You can select,

- a. whether to activate this function, and if so
- b. after what period of time the camera should be switched off.

In this way, you can tailor this function to your own personal working methods and also significantly extend the life of your battery charge.

Setting the function

1. In the main menu (see p. 94/113) select **Auto Power Off** (5.1.12), and
2. the desired function.

Note:

Even if the camera is in standby mode, i.e. the displays have gone out after 12s, or the active **Auto Power Off** function has turned it off, it can be restarted at any time by pressing the shutter release button (1.20).

Button acknowledgement and signal tones

With the LEICA M8.2, you can decide whether you want your settings and other functions and warning messages to be acknowledged by an acoustic signal – two volumes are available – or whether operation of the camera should be largely silent.

A click or a beep tone is used as an acknowledgement, which can be activated individually to confirm presses of buttons and to indicate a full memory card.

Note:

By factory default, the signal tones are deactivated.

Setting the functions

1. In the main menu (see p. 94/113), select **Acoustic Signal** (5.1.20) and
2. call up the sub-menu. There are three items, **Volume**, **Key Click** and **SD card full**.
3. Select **Volume**, and
 - A further sub-menu appears containing the 3 alternatives **Off** (no tones at all), **High** (loud) and **Low** (quiet).
4. Choose the desired function from this sub-menu.
 - After confirmation, the initial monitor screen appears again.
5. In the other two sub-menus, choose whether or not you want to activate the tones for the respective functions.

Basic picture settings

Resolution

The picture data can be recorded at four different pixel settings, i.e. resolutions. This allows you to adjust the setting precisely to the intended use or to the available memory card capacity.

At the highest resolution (which also means the largest data volume), which you should select for optimum quality for larger prints, it is of course possible to save considerably fewer pictures to a card than at the lowest resolution, which is perfectly adequate for sending a picture by e-mail or for a website.

Notes:

- The digital negative memory (**DNG**, see the next section) is always performed at the highest resolution.
- The details in the table relate to the 1GB memory card supplied and retention of the same settings. If, on the other hand, you change the resolution and/or compression rate, the resulting number of pictures will be different.

Setting the function

1. In the picture parameters menu (see p. 95/113) select **Resolution** (5.2.5)
2. in the respective sub-menu, select the desired resolution.

Possible resolutions and resulting numbers of pictures

Compression rate/ file format Resolution	DNG	JPG fine (low compression) ¹	JPG basic (normal compression) ¹	DNG+ JPG fine ¹	DNG+ JPG basic ¹
■ (10 MP)	93	276	386	70	75
■ (6 MP)	-	491	687	78	82
■ (2,5 MP)	-	>1000	>1000	86	88
■ (1 MP)	-	>1000	>1000	90	91

¹Average values, can differ significantly depending on the subjects.

Compression rate/file format

The picture data can optionally be recorded

- a. with one of two different compression rates – **JPG fine / JPG basic**,

or

- b. using the DNG file format,

or

- c. using combinations of one of these two compression rates and **DNG**, i.e. two files are generated per picture. In these cases the JPG file will always be saved with the selected resolution.

On the one hand this permits a precise match to the intended usage and the available memory card capacity, and on the other hand provides security and flexibility essential for subsequent decisions on usage.

Setting the function

1. In the picture parameters menu (see p. 95/113) select **Compression** (5.2.4)
2. in the respective sub-menu, select the desired compression / combination.







Notes:

- The standardized DNG (Digital Negative) format is used for uncompressed storage of completely unprocessed raw picture data.
- If **DNG** is selected for raw data storage, the resolution is set automatically, and irrespective of the existing setting (for the respective JPEG format) to  (10 MP) (see previous section).
- If simultaneous storage of picture data as **DNG** and **JPG** is selected, the JPEG format for the existing resolution setting is used, i.e. the resolutions of the two files can be quite different.
- A high compression rate such as for **JPG basic** can result in very fine structures in the subject being lost or incorrectly reproduced (artifacts; e.g. “stepped” diagonal edges).
- The remaining number of pictures shown in the monitor does not necessarily change after every picture. This depends on the subject; with JPEG files very fine structures result in higher quantities of data, homogeneous surfaces in lower quantities. The details in the table are based on an average file size for the set resolution. The file sizes are often smaller, depending on the picture content and the compression rate, which means that the remaining memory capacity is then greater than previously calculated and displayed.
- For the possible compression rates and the resulting numbers of pictures, refer to the table in the previous section.

White balance

In digital photography, white balance ensures neutral reproduction of color in any light. It is based on the LEICA M8.2 being preset to reproduce a particular color as white.

With the LEICA M8.2, you can choose from nine different settings:

- **Auto** – For automatic control, which provides neutral results in most situations,
- Six fixed presets for the most frequent light sources,
 - , for indoor pictures with (prevailing) incandescent lamp light
 - , e.g. for indoor pictures with (prevailing) light from fluorescent tubes
 - , e.g. for outdoor pictures in sunshine,
 - , e.g. for pictures with (prevailing) electronic flash illumination
 - , e.g. for outdoor pictures with cloudy skies,
 - , e.g. for outdoor pictures with the main subject in shadow,
 -  For manual setting by measurement, and
- **Kelvin Setting**.¹ – For a directly adjustable color temperature value.

¹ All color temperatures are specified in Kelvin.

Note:

Setting to **Auto** allows the white balance to be adjusted for correct color reproduction when using an electronic flash unit that satisfies the technical requirements of a System Camera Adaption (SCA) for the System 3000 and has an SCA-3502 adaptor (from version 4 onwards).

However, if other flash units are used, which are not specially adapted to the LEICA M8.2, the camera white balance will not be automatically adjusted, and the setting  should be used.

Setting the function

For automatic or fixed settings

1. In the picture parameters menu (see p. 95 / 113) select **White Balance** (5.2.3)
2. in the associated sub-menu select the desired function.

For direct setting of color temperature

You can directly set values between 2000 and 13100 (K¹) (from 2000 to 5000 K in increments of 100, from 5000 to 8000 K in increments of 200 and from 8000 to 13,100 K in increments of 300). This provides you with a broad scope, covering almost all color temperatures that can occur in practice and within which you can adapt the color reproduction very sensitively to the existing light color and/or your personal preferences.

1. In the picture parameters menu (see p. 95/113) select **White Balance** (5.2.3), and
2. in the respective sub-menu, select the **Kelvin Setting** option.
3. Use the adjusting dial (1.30) or the up/down direction button (1.31) to select the desired value, and
4. confirm your setting by pressing the **SET** button once again.

For manual setting by metering

1. In the picture parameters menu (see p. 95/113) select **White Balance** (5.2.3), and
2. in the respective sub-menu, select the **M** option.
3. Press the **SET** button (1.22).
 - The message **Attention! Aim the camera at a white surface and press the shutter release appears in the monitor.**
4. The actual setting is made by subsequently taking a picture in which you should aim at a white or neutral grey surface in the center of the picture.
 - Instead of the menu list, the picture just taken will appear in the monitor, and within it the message **White balance set**. However, if the exposure is not assessed as correct or the surface you aim at is not neutral, this is indicated by **Insufficient Exp.** or **White balance not possible**. In such cases, repeat step 2 with the correct exposure setting or with a more neutral surface.

A value set in this way remains saved for and will be used for all pictures until it is superseded by a new metered value or you use one of the other white balance settings.

Note:

A white balance setting achieved by metering which has already been saved can also be recalled, even after the white balance setting had been changed over to one of the other settings. This is done by performing steps 1-3 and (instead of step 4) pressing the **SET** button once again.

¹ All color temperatures are specified in Kelvin.

ISO sensitivity

In traditional photography, the choice of the ISO value reflects the light sensitivity of the film used. Higher speed films allow faster shutter speeds and/or smaller apertures and vice versa, at the same brightness.

The ISO setting on the LEICA M8.2 also allows the shutter speed/aperture value to be adjusted to meet the requirements of the relevant situation, in five steps.

Optimum reproduction quality is achieved by using the lowest setting, ISO **160**. The higher film speeds ISO **320**, **640**, **1250** and **2500** result in increased "picture noise". This effect can be compared to the "graining" that occurs with highly sensitive films.

As well as the five fixed settings, the LEICA M8.2 also features an **AUTO ISO** function, in which the camera automatically adjusts the sensitivity to the ambient brightness. When used with aperture priority mode¹ (see p. 128), this considerably extends the range of the automatic exposure control, specifically by up to 4 aperture stops.

However, when using the function it is also possible to specify priorities, for example for compositional reasons². This enables you to limit the range of sensitivities used – e.g. because of the noise mentioned above, and also to set the exposure time above which the automatic increase in sensitivity is activated, e.g. to reliably prevent blurred pictures.

Setting the function

1. In the picture parameters menu (see p. 95 / 113) select **ISO** (5.2.1), and
2. and in the respective sub-menu select the desired film speed or the automatic setting. If **AUTO ISO** is set, you can adjust the function to your style of photography or to your composition preferences².
3. In the main menu (see p. 94 / 113), select **AUTO ISO Setup** (5.1.4) and

4. in the respective sub-menu select **MAX ISO** and **Max. Exp. Time**.

5. In the **MAX ISO** sub-menu, select the range in which you want the automatic setting to work by specifying the maximum sensitivity to be used. and/or

In the **Max. Exp. Time** sub-menu, specify whether you want to leave it to the camera to ensure shutter speeds that will prevent blurring – by selecting **Lens dependent**³ or whether you want to specify a particular maximum shutter speed in the range between $\frac{1}{500}s$ and 1s (in whole steps).

If you select **Lens dependent**, the camera only switches to a higher sensitivity if the shutter speed would

fall below the $\frac{1}{\text{Focal length}}$ threshold due to poor brightness, e.g. speeds slower than $\frac{1}{30}s$ for a 28 mm lens.

¹ The function is not available when setting the exposure manually and when using flash units (always with $\frac{1}{180}s$). In snapshot mode **S** (see p. 96), this function is always active.

² These options are not available in snapshot mode **S**.

³ This function requires the use of coded lenses (see p. 102).

Image properties/Contrast, sharpness, color saturation

One of the many advantages of electronic photography over traditional photography is that it is very easy to change critical properties of a picture. While photographic software – after recording and transfer to a computer – provides great scope for doing this, the LEICA M8.2 itself allows you to influence three of the most important picture properties even before taking the picture:

- The contrast, i.e. the difference between light and dark sections of the image, determines whether an image has a more "flat" or "brilliant" effect. As a consequence, the contrast can be influenced by increasing or reducing this difference, i.e. by lighter reproduction of light sections of the image and darker reproduction of dark sections.
- Sharp reproduction – at least of the main subject – using the correct distance setting is a prerequisite for a successfully picture. In turn, the impression of sharpness of a picture is to a great extent determined by the sharpness of the edges, i.e. by how small the transition area between light and dark is at the edges in the picture. The impression of sharpness can thus be changed by expanding or reducing these areas.

- The color saturation determines whether the colors in the picture tend to appear as "pale" and pastel-like or "bright" and colorful. While the lighting and weather conditions (hazy / clear) are given as conditions for the picture, there is definite scope for influencing the reproduction here.

All three picture properties can be adjusted – independently – to five different levels using the menu control, so that you can set the optimum values for any situation, i.e. the prevailing lighting conditions. In the case of **Color Saturation**, **Black+White** can also be selected as a sixth option.

Note:

If the file format **DNG** is specified, these settings have no effect as in this case the image data is always saved in its original form (changes must be made later on the computer).

Setting the functions

1. In the main menu (see p. 94 / 113), select **Sharpening** (5.1.5), **Color Saturation** (5.1.6), or **Contrast** (5.1.7), and
2. in the sub-menu select the desired level (**low**, **medium low**, **standard**, **medium high**, **high**).

Working color space

The requirements in terms of color reproduction differ considerably for the various possible uses of digital picture files. Different color spaces have therefore been developed, such as the standard RGB (red/green/blue) that is perfectly adequate for simple printing. For more demanding image processing using appropriate programs, e.g. for color correction, Adobe® RGB has become established as the standard in the relevant sectors. In the professional pre-printing stage, ECI is used extensively. The LEICA M8.2 allows setting to one of these three color spaces: **sRGB**, **Adobe RGB** or **ECI RGB**.

Note:

When using **ECI RGB** the depiction of the colors in the monitor is paler than when reproduced in reality (i.e. in a print).

Setting the function

1. In the main menu (see p. 94/113), select **Color Management** (5.1.15) and
2. in the associated sub-menu select the desired function.

Notes:

- If you want to have your prints produced by major photographic laboratories, mini labs or Internet picture services, you should always select the **sRGB** setting.
- The **Adobe RGB / ECI RGB** settings are only recommended for professional image processing in completely color-calibrated working environments.

Holding the camera correctly



For sharp, blur-free pictures, the camera should be held as steadily and comfortably as possible. To ensure suitably secure “three point support” for the LEICA M8.2, hold the camera with the right hand, with the index finger on the shutter release button and the thumb behind the rear of the camera body for stabilization. The left hand either supports the lens from below, ready for fast focusing adjustments, or is around the whole camera. Holding the camera against the forehead and cheek provides additional support. For portrait format pictures, turn the LEICA M8.2 to the left. The hands remain in the same position as for pictures in landscape format.

However, you can also turn it to the right. In this case, it may be advantageous to release the shutter with the thumb.



Notes:

- As a practical accessory, we recommend the Handgrip M8, which allows you to hold the LEICA M8.2 extremely steadily and to carry it with one hand (order no. 14 471 black, 14 472 silver).
- The LEICA M8.2 is fitted with an integral sensor which detects the position of the camera – horizontal or vertical (both directions) – for each picture. This information automatically allows the pictures to be presented upright when subsequently displayed on a computer running the appropriate programs.

Bright-line view and range finder

The LEICA M8.2's bright-line view and range finder is not only a very high-quality, large, brilliant and bright viewfinder, it is also a highly accurate range finder coupled to the lens. It has an enlargement factor of 0.72 x.

If lenses with nominal focal lengths* 24, 28 (Elmarit 28 mm from serial number 2 411 001), 35, 50, 75 and 90 mm are used, the associated bright-line frame automatically adjusts to the combinations 24+35 mm, 28+90 mm, 50+75 mm.

The size of the bright-line frame is matched to the initial format of the LEICA M8.2 and corresponds to a sensor size of around 18x27 mm at a setting distance of 2 m. At longer distances, the camera records more of the subject than can be seen in the bright-lines, at shorter distances slightly less.

The bright-lines are linked to the distance setting in such a way that parallax – the misalignment between the lens and the viewfinder axes – is automatically compensated and the bright-line image and the picture are identical over the entire distance setting range 0.7 m to ∞.

In the middle of the viewfinder image is the rectangular distance metering image, which is brighter than the surrounding image field. All Leica M lenses from 16 to 135mm focal length connect with the range finder when used on the LEICA M8.2.

If the exposure meter is turned on, the exposure meter LEDs and the flash symbol LED appear at the lower edge of the viewfinder image.

For more details about setting the distance and exposure metering, together with flash mode, refer to the relevant sections on pages 126/127/134.

Note:

Therefore, when using longer focal lengths than those for which there are bright-line frames (90 mm, see above) such as the 135 mm models, their image field in the camera viewfinder – which is very small to start with – can only be “determined” very imprecisely.

Frame selector

The frame selector (1.8) expands the possibilities of the LEICA M8.2 viewfinder. This built-in universal viewfinder allows you to display the frames that do not belong to the lens currently being used at any time. You can then see immediately if, for image composition reasons, it would be better to photograph the relevant subject using a different focal length.

If the lever is swung outwards, that is away from the lens, the image field limits for 24 and 35 mm focal length are shown*.

If the lever is moved to its vertical central position, the image field limits for the focal lengths 50 and 75 mm are shown.

If the lever is swung inwards, that is towards the lens, the image field limits for 28 and 90 mm focal length are shown*.

* See “The extension factor”, p. 105

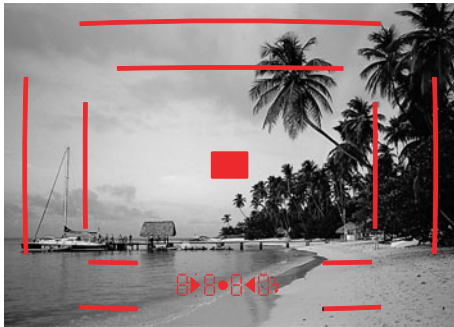

24 mm + 35 mm

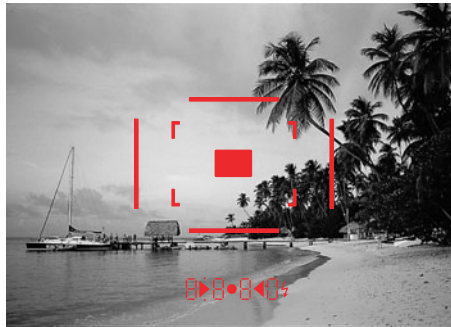

50 mm + 75 mm

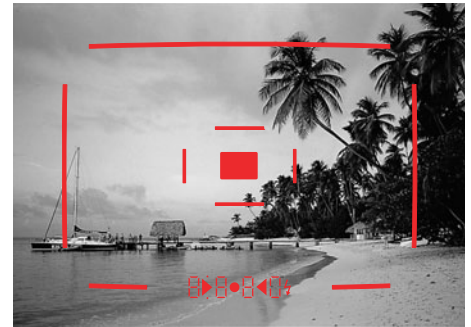

28 mm + 90 mm



Distance metering

Due to its large effective metering basis, the range finder on the LEICA M8.2 is very precise. The benefits of this are particularly noticeable when using wide-angle lenses with their relative high depth of field.

Mechanical metering basis (Distance between the optical axes of the viewfinder window and the range finder viewing window)	x viewfinder magnification	= Effective metering basis
69.25 mm	x 0.68	= 47.1 mm

The range finder metering field is visible as a bright, sharply defined rectangle in the center of the viewfinder. If you keep the large viewfinder window (1.6) closed, only the activated bright-line and this metering field remain visible. The focus can be set using either the superimposed image or split image method:

Superimposed image method (double image)

In a portrait, for example, aim the metering field at the eye and turn the distance setting ring on the lens until the contours in the metering field are brought into line. Then choose the subject detail.

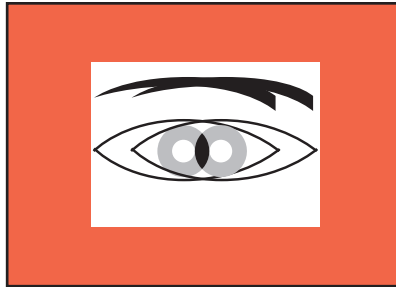

Double image = out of focus

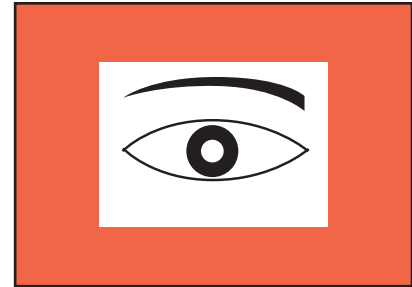

Coincident image = in focus

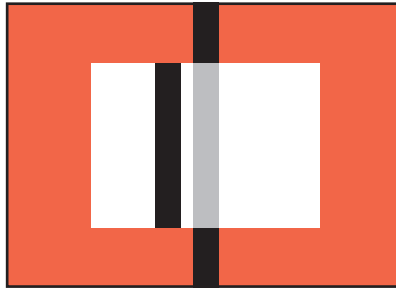

Interrupted line = out of focus

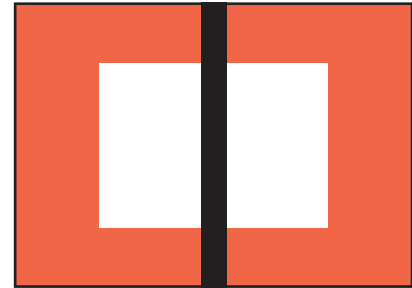

Continuous line = in focus

Split image method

When taking photographs of architecture, for example, aim the range finder metering field at the vertical edge or another clearly defined vertical line and turn the distance setting ring on the lens until the contours of the edge or line can be seen at the limits of the metering field with no misalignment. Then choose the subject detail.

In practice, there is often no clear distinction between the two methods. The two criteria can be used to great effect in combination.

Exposure metering

On the LEICA M8.2, exposure metering for the available ambient light is done through the lens with the working aperture. The light reflected by a bright blade in the first shutter curtain is captured by a photo diode and measured. This silicon photo diode with forward-facing convex lens is positioned at the center lower edge, on the camera bottom.

The appropriate shutter speed / aperture combinations for a correct exposure are indicated by the viewfinder or monitor displays or are determined with their assistance.

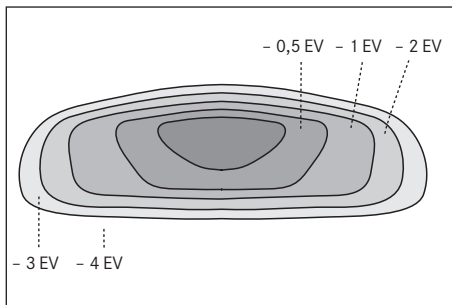

When using snapshot mode **S**, the aperture (and the distance) are manually preset based on the values indicated by the camera which then calculates the corresponding shutter speed automatically. The red circular LED lights up as confirmation. Everything else about snapshot mode **S** is described in the relevant section on pages 96/95).

When in aperture priority mode the aperture is selected manually, and the camera then determines the appropriate shutter speed automatically. In this mode a digital LED display indicates the resulting exposure time (e.g. **1000**)

If both values are set manually, a light balance made up of three red LEDs (▶ ◂ ◃) is used to correct the exposure. When the setting is correct, only the central circular LED is lit up.

Turning the exposure meter on/off

The exposure meter is activated by pressing down the shutter release (1.20) to its first pressure point, provided that the camera is switched on at the main switch (1.19) and the shutter speed setting dial (1.18) is not set to **B**.

The metering readiness of the exposure meter is indicated by one of the displays in the viewfinder lighting up continuously, signaling:

- in aperture priority mode by the digital LED display of the shutter speed,
- and in manual mode by the lighting of either of the two triangular LEDs, either individually or in conjunction with the center circular LED.

If the shutter release button is let go, without activating the shutter, the exposure meter remains turned on for around 12 s more, and the respective LED(s) remain lit for the same time.

If the shutter speed dial is set to **B**, the exposure meter is disabled.

Notes:

- If the displays go out, the camera is in “standby” mode.
- With very little ambient light, i.e. at the limits of the exposure meter’s range, it can take around 0.2 s for the LEDs to light up.
- In aperture priority mode, if the correct exposure cannot be achieved using the available shutter speeds, the respective display flashes as a warning (for more details, refer to the “Aperture priority mode” section on p. 128).
- If under very low lighting conditions and manual mode the exposure meter reading is out of range, the left hand triangular LED gives a warning by flashing. In aperture priority mode the shutter speed remains displayed. If the required shutter speed exceeds the longest possible shutter speed of 32 s, this display also flashes.
- If the camera is out of use for an extended period or is stored in a case, always switch it off at the main switch. This prevents any power consumption, including that which continues to occur in standby mode after the exposure meter is turned off automatically and the display is extinguished. This also prevents taking pictures accidentally.

Exposure modes

The LEICA M8.2 provides three exposure modes: A snapshot mode, aperture priority and manual setting. Depending on the subject, situation and your individual preferences, you can thus choose between

- extremely convenient, reliable and fast, almost fully automatic operation (i.e. only a few preliminary settings that only need to be made once),
- the familiar “semi automatic” operation, or
- setting a fixed shutter speed and aperture.

Everything else about snapshot mode **S** is described in the relevant section on pages 96/97).

Aperture priority

If the shutter speed dial (1.18) is in the **A** position the electronics within the camera generates the shutter speed automatically and continuously in the range $1/4000\text{s}$ to 32s, in accordance with the sensitivity setting, the metered brightness and the manually selected aperture. The generated shutter speed is displayed digitally in the camera viewfinder; for better clarity it is displayed in half steps.

For shutter speeds longer than 2s the remaining exposure time is counted down and displayed in seconds after the shutter release. The actually generated and continuously controlled shutter speed can however

vary from the half step value displayed: For example, if **16** (as the nearest available value) is shown in the display before releasing the shutter, but the generated shutter speed is in fact longer, as is shown by the countdown after the shutter release starting at **19**.

Under extreme lighting conditions the exposure meter may even, based on all the parameters, generate a shutter speed that is outside its working range, i.e. brightnesses that demand an exposure shorter than $1/4000\text{s}$ or longer than 32s. In such cases the specified minimum or maximum shutter speed is nevertheless used, and these values flash in the viewfinder, as a warning.

Metering memory lock

Often the principal subject for artistic reasons is not in the center of the picture, and such important subject items may also be excessively bright or dark. However, the LEICA M8.2 metering is strongly center-weighted; as described in the “Exposure metering” section on p. 127, essentially only an area in the center of the picture is calibrated for its average grey scale value.

Subjects and situations of this sort can be overcome very easily even within aperture priority mode, using metering memory lock.

To do this:

1. the camera is first turned so that the center of the viewfinder points either at the important part of the subject, or alternatively at some other detail of equivalent average brightness,
2. and by pressing the shutter release button (1.20) to the second pressure point this metered value is measured and stored. As long as the pressure point is held, a small red dot appears in the viewfinder at the top in the digits line for confirmation, and the shutter speed ceases to change even if the lighting conditions change.
3. Keeping the shutter release button pressed, turn the camera back to the intended picture,
4. and the shutter can then be released using the exposure metering originally determined.

Changing the aperture setting after locking the metered value has no effect on the shutter speed, and will lead to an incorrect exposure.

Memory lock is cancelled when the shutter release button is let go from the pressure point.

Exposure compensation

Exposure meters are calibrated to an average grey scale value (18% reflection), which corresponds to the brightness of a normal, i.e. average photographic subject. If the actual subject detail does not match this assumption, an appropriate exposure compensation can be performed.

In particular for several exposures in succession, for instance if for any reason a series of pictures is taken deliberately somewhat underexposed or overexposed, an exposure compensation is a very useful function: Once set, unlike metering memory lock, it remains in effect until (deliberately) cancelled (more details on metering memory lock can be found in the respective section on p. 128).

The LEICA M8.2 allows exposure compensation in a range of up to ± 3 EV in $1/3$ EV steps (EV: Exposure Value).

Setting the function

The LEICA M8.2 provides two options for setting an exposure compensation: Setting using the menu control is recommended if, for example, you know before taking a series of pictures that you want your subjects to be slightly under or overexposed. The exceptionally fast option using the setting dial is ideal when unexpected situations occur and enables you to track your subject in the viewfinder without interruptions.

A. Using menu control

1. In the picture parameters menu (see p. 95/113) select **EV** (5.2.2), and
2. in the associated sub-menu select the compensation value.

B. Using the setting dial

As long as you keep the shutter release button pressed to the 1st pressure point*, you can enter an exposure compensation by turning the setting dial (1.30) – clockwise for positive values and anticlockwise for negative values.

While you are doing this, the digital display (2.1.1) in the viewfinder (1.28) shows the set values as follows: **3.0-...1.0- 0.7- 0.3- 0.3 0.7 1.0...3.0** (for -3 EV,...-1 EV, - $2/3$ EV, - $1/3$ EV, + $1/3$ EV, + $2/3$ EV, +1 EV, ...+3 EV).

A compensation set can be reset in either of the two ways and is always displayed both in the menu and in the viewfinder (when the shutter release button is pressed to the 1st pressure point) regardless of how it was initially set.

* (for further details on how the shutter release button works, see the respective section as of p. 108)



Note:

An exposure compensation set on the camera only influences the measurement of available light. If you want to simultaneously use compensation of the TTL flash exposure measurement in flash mode – in parallel or in the opposite direction, you must make this additional setting (on the flash unit). See the sections on flash mode from p. 134 for details.

Example of a positive compensation

With very bright subjects, such as snow or a beach, the exposure meter selects a relatively short exposure time due to the extreme brightness. As a result, the snow shows up in an average grey and any people in the photograph are too dark: this is under exposure! To remedy this problem, the exposure time needs to be extended or the aperture increased, i.e. a setting of perhaps $+1\frac{1}{3}$ EV needs to be made.

Example of a negative compensation

For very dark subjects that reflect very little light, the exposure meter selects an exposure time that is far too long. A black car will appear grey: this is over exposure! The exposure time needs to be shortened, i.e. a setting of e.g. -1 EV is required.

Manual exposure setting

If the exposure setting is performed entirely manually, the shutter speed dial (1.18) must be clicked to one of the engraved speeds or to one of the intermediate values.

Then:

1. switch the exposure meter on and
2. turn the shutter speed dial and /or the aperture setting ring on the lens – in each case in the direction indicated by the triangular LED that is lit up – until only the circular LED is lit up.

As well as the direction of rotation of the shutter speed dial and aperture setting ring necessary for correct exposure, the three LEDs in the light balance also indicate underexposure, overexposure and correct exposure in the following way:

- ▶ underexposure by at least one aperture stop; turning to the right is required
- ▶• underexposure by $1/2$ an aperture stop; turning to the right is required
- Correct exposure
- ◀ overexposure by $1/2$ an aperture stop; turning to the left is required
- ◀ overexposure by at least one aperture stop; turning to the left is required

Note:

For shutter speeds longer than 2s the remaining exposure time is counted down and displayed in seconds after the shutter release.

B setting / T function

The **B** setting keeps the shutter open as long as the shutter release button remains pressed. This allows exposures of any length (up to maximum 1000 s).

In conjunction with the self timer, a T function is also available: If you set **B** and activate the self timer (see also p. 147) by tapping the shutter release button, the shutter opens automatically after the selected delay time. It then remains open until you press the shutter release button a second time – you do not need to hold the button down. This enables you to largely prevent any blurring, even with long exposures, by pressing the shutter release button.

In both cases, the exposure meter is disabled; after the shutter is released however the digital display in the viewfinder gives the elapsed exposure time in seconds, for guidance

Notes:

- Long exposures can be associated with very heavy picture noise.
- To reduce this annoying phenomenon, following exposures with slower shutter speeds (approx. below $1/30$ s, differing depending on menu settings) the LEICA M8.2 automatically takes a second “black picture” (taken with the shutter closed). The noise present in this parallel picture is then digitally “subtracted” from the data set for the real picture.
- This doubling of the “exposure” time can be significant in particular at longer shutter speeds, and must be allowed for. During this time the camera should not be switched off.
- For shutter speeds of 2 s or more the message **Noise reduction in progress 12 s*** appears in the monitor.

* Time quoted is an example only

Exposure meter metering range

The metering range at room temperature, normal humidity and ISO 160/23 is EV 0 to 20, or $f/1.0$ and 1.2 s to $f/32$ and $1/1000$ s.

Working below the metering range

If under very low lighting conditions and manual mode the exposure meter reading is out of range, the left hand triangular LED gives a warning by flashing. In aperture priority mode the shutter speed remains displayed. If the required shutter speed exceeds the longest possible shutter speed of 32 s, this display also flashes.

As the exposure is metered with the working aperture, this situation can come about by stopping down the lens.

Even if you are below the metering range, the exposure meter remains on for around 12 s after you let go the shutter release button. If the lighting conditions improve in this time (e.g. through a change in the subject detail or opening of the aperture), the LED display changes from flashing into being continuously lit, indicating that the meter is ready.

Metering diagram

The metering diagram (see p. 133) applies to all exposure modes.

Information on the metering range of the exposure meter can be found on the right-hand side of the diagram, while information on the working range of the focal plane shutter and the lenses are on the left. Between them, the exposure values (EV) can be read off.

The metering range of the exposure meter is given on the right of the diagram in cd/m^2 (candela per square meter).

Above this, the sensitivity settings (SV = Speed Value) are given in ISO values. On the left of the diagram, you can see the shutter speed details in seconds (TV = Time Value). The working range of the LEICA M8.2's focal plane shutter is represented by a shaded area in the adjacent column. In the **B** setting, the range is open at the top. The aperture values (AV) can be read off in the bottom left.

Example **A** highlights the relationships between the speed, light intensity (brightness), shutter speed and aperture.

From the specified sensitivity (ISO 160), first follow the vertical line to its intersection with the horizontal line belonging to the corresponding brightness. In this example, this is $2500 \text{ cd}/\text{m}^2$, which corresponds to bright sunshine. The line then runs diagonally as far as the vertical line for the set aperture and from there horizontally to the left until it reaches the necessary shutter speed ($1/250$ s). The exposure value (EV 15) can also be read off in the diagonal course of the line.

Example **B** shows that in candlelight and with a sensitivity of ISO 640 ($0.6 \text{ cd}/\text{m}^2$) it is necessary to use aperture 1.4 and a shutter speed of $1/15$ s. Stop 16 on the lens, for example cannot be used, as the associated shutter speed of 8 s is not available on the shutter speed setting dial. Because only 6 s can be set as the highest shutter speed using the dial, direct metering is no longer possible. Conversion or reading the correct shutter speed from this diagram is therefore essential.

In aperture priority mode on the other hand, the LEICA M8.2 automatically generates shutter speeds up to 32 s, so that in the above example every aperture on the lens can be used.

The area with a grey background illustrates the considerably extended range for automatic exposure control with snapshot mode **S** by simultaneously utilizing the optionally available automatic ambient brightness controlled ISO sensitivity setting.

Metering Diagramm

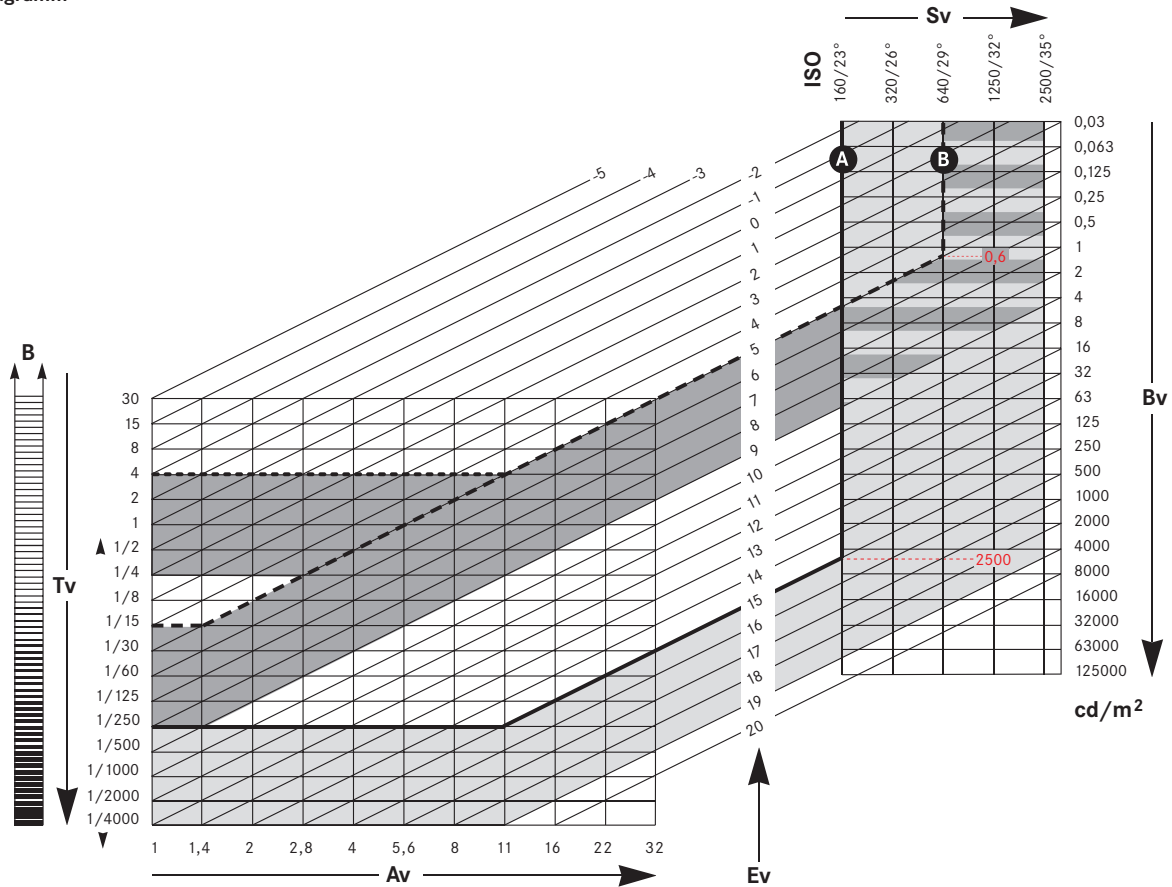

General information on flash exposure metering and control



The LEICA M8.2 determines the necessary flash power by firing one or more ranging flashes, fractions of a second before taking the actual picture. Immediately after this, at the start of exposure, the main flash is fired.

All factors that influence the exposure (such as filters and changes to the aperture setting) are automatically taken into account.

Compatible flash units

The following flash units, when used on the LEICA M8.2, are capable of all the functions described in this manual:

- The LEICA SF 24D system flash unit (order no. 14 444). With its compact size and design that matches the camera, it is particularly suitable. Thanks to its permanently attached flash foot with associated additional control and signal contacts, which in automatic mode transfer a range of data and settings, it is very easy to use.
- Flash units which satisfy the technical requirements for System Camera Adaption (SCA) System 3000, are fitted with the SCA-3502/3501¹ adapter and which allow guide number control.

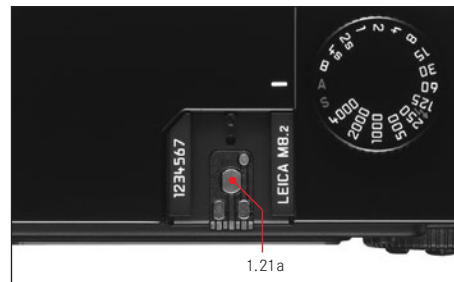

Other commercially available flash attachments with standard flash foot^{2,3} and positive central contact, and which are triggered by the central contact (X-contact, 1.21a), can also be used. We recommend the use of modern thyristor-controlled electronic flash units.

¹ When using SCA-3502 adapter (from version 4) the white balance (see p. 119) can be set to **Auto** for correct color reproduction – this is done automatically in snapshot mode S.

² If flash units not specially adapted to the LEICA M8.2 are used, the camera white balance will not be automatically adjusted, and the  setting should be used (see p. 112). As a result, to ensure correct color reproduction you should not use snapshot mode S in such cases.

³ The aperture specified on the lens must be manually set at the flash unit.

Attaching the flash unit



When attaching a flash unit to the LEICA M8.2 flash shoe (1.21), you should ensure that the foot of the flash unit is fully inserted and the clamping nut (if fitted) is tightened to prevent it accidentally falling out. This is particularly important for flash units with additional control and signal contacts, because if the flash shoe moves from its position in the flash shoe the necessary contacts can be broken, leading to malfunctions.

Note:

Before attaching the flash, the camera and the flash unit must be turned off.

Flash mode

Fully automatic camera-controlled flash operation is available for the LEICA M8.2 when using system-compatible flash units as described in the previous section, in all three exposure modes – snapshot mode **S**, aperture priority mode **A** and manual mode.

In addition, automatic illumination regulation is performed in all three exposure modes. This means that in order to ensure a balanced relationship between flash and other lighting at all times, the flash power is reduced by up to $1\frac{2}{3}$ EV as ambient brightness increases. However, if the ambient brightness plus even the shortest possible flash sync speed of $1/180$ s would cause overexposure, the flash will not be fired in aperture priority mode. In such cases the shutter speed is governed by the ambient brightness and is shown in the viewfinder.

In aperture priority **A** and manual mode, but not in snapshot mode **S**, the LEICA M8.2 also allows you to use other, more artistically interesting flash techniques such as synchronization of the flash firing with the second instead of with the first shutter curtain and of flashes with longer shutter speed than the standard sync speed of $1/180$ s. These functions are set on the camera using the menu (for more details, refer to the relevant sections below).

In addition the LEICA M8.2 loads the sensitivity setting to the flash unit.

This allows the flash unit, provided it has received such information and the aperture manually set on the lens is also input to the flash unit, automatically to adjust its range values accordingly. The sensitivity setting cannot be changed at the flash unit.



Notes:

- The settings and functions described in the following sections relate exclusively to flash units that are system compatible to the LEICA M8.2.
- An exposure compensation set on the camera (see p. 129) only influences the measurement of available light. If you want to simultaneously use compensation of the TTL flash exposure measurement in flash mode – in parallel or in the opposite direction, you must make this additional setting (on the flash unit).
- More details of flash use, in particular for other flash units not specially adapted to the LEICA M8.2 and for different flash modes can be found in the respective user guides.

Settings for camera-controlled automatic flash mode

After the flash unit in use has been switched on and set to the mode for GNC (= Guide Number Control), the following actions on the LEICA M8.2 are necessary:

1. Before taking each flash picture the exposure metering is first performed by gently pressing the shutter release button, so that the display in the viewfinder shows the shutter speed or switches over to the light balance. If this stage is missed out by fully depressing the shutter release button in one quick movement, the flash unit will not fire even if required.
2. The shutter speed dial must be set to **A**, **S** or to flash sync speed  ($1/180$ S), or – for special effects with a long exposure time – even to **B**. In aperture priority mode the camera automatically switches to the flash sync speed set in the menu, or to the time range (see “Selecting the sync speed / the sync speed range”, p. 138).
3. The desired aperture, or the aperture required for the respective distance of the subject, must be set.

Note:







If the automatic (see “Flash mode”, p. 135) or manually set shutter speed is shorter than $1/180$ S, the flash will not be fired.

The flash lighting displays in the viewfinder with system-compatible flash units



A flash-shaped LED (2.1.3) appears in the LEICA M8.2 viewfinder as confirmation and display of the various operating conditions. This LED appears together with the displays for exposure metering for the ambient light level, described in the respective sections.

In automatic flash mode

(flash unit set to Guide Number Control)

-  does not appear despite the flash unit being switched on and ready for use:
The camera is manually set to a shorter speed than $\frac{1}{180}$ s. In such cases the LEICA M8.2 will not fire the flash unit even though it is switched on and ready for use.
-  flashes slowly (at 2Hz) before the picture is taken:
The flash unit is not yet ready for use
-  is lit up before the picture is taken:
The flash unit is ready for use.
-  remains continuously lit after taking the picture, and the other displays go out:
The flash exposure was successful, the flash unit remains ready for use.
-  flashes rapidly after taking the picture (at 4 Hz), and the other displays go out:
The flash exposure was successful, but the flash unit is not yet ready for further use.
-  goes out after taking the picture, together with the other displays:
Underexposure, perhaps due to the choice of too small an aperture stop for the subject. If the flash unit is set to a partial discharge power, because of the lower power requirement it may be ready for use despite the flash LED not lighting up.

When the flash unit is set to camera control (A) or manual mode (M)

-  does not appear despite the flash unit being switched on and ready for use:
The camera is manually set to a shorter speed than $\frac{1}{180}$ s. In such cases the LEICA M8.2 will not fire the flash unit even though it is switched on and ready for use.
-  flashes slowly (at 2Hz) before the picture is taken:
The flash unit is not yet ready for use.
-  is lit up before the picture is taken:
The flash unit is ready for use.

Selecting the sync speed / the sync speed range

While the shutter speed used has no bearing on the control of the flash exposure (because the flash duration is very much shorter than this), the reproduction of the available light is very strongly influenced by the shutter speed and by the aperture setting. A fixed setting of the shortest possible shutter speed for flash operation, the sync speed, leads unnecessarily in many situations to a greater or lesser underexposure of all parts of the subject not illuminated by the flash. The LEICA M8.2 allows you to combine flash operation with the shutter speed generated in aperture priority mode to subtly change the lighting conditions for the respective subject to suit your picture composition ideas. You can choose any of five ways of doing this:

1. Lens dependent

Automatic control of shutter speeds depending on the focal length of the lens used (based on the rule of thumb for blur-free pictures with a hand-held camera = $\frac{1}{\text{focal length}}$ e.g. $\frac{1}{60}$ s using the Summicron-M 50 mm f/2) up to sync speed $\frac{1}{180}$ s.*

2. Off ($\frac{1}{180}$ s)

Fixed setting to the shortest possible shutter speed of $\frac{1}{180}$ s, e.g. for the sharpest possible reproduction of moving subjects and the illuminating flash.

* Only when using Leica M lenses with 6-bit coding in the bayonet and lens identification enabled in the menu (see p. 94/103/113)

3. Up to $1/30$, 4. Up to $1/8$ and 5. Up to 32s

Automatic control of all shutter speeds from the specified value down to the sync speed of $1/180$ s.

Notes:

- Manual exposure control also allows any shutter speed to be set down to the sync speed of $1/180$ s.
- When using snapshot mode **S** (see p. 96) with coded lenses (see p. 102) the lens-specific control is fixed and with non-coded lenses it is $1/180$ s.

Setting the function

1. In the main menu (see p. 94/113) select **Auto Slow Sync** (5.1.14), and
2. in the respective sub-menu, select the desired option.

Selecting the firing moment

Flash photographs are illuminated by two light sources, the available light and the light from the flash. Parts of the subject that are exclusively or primarily illuminated by the flash are almost always reproduced extremely sharply (with correct focusing) due to the extremely fast pulse of light. By contrast, all other parts of the subject – those that are sufficiently illuminated by the available light or illuminate themselves – are portrayed with different degrees of sharpness in the same picture.

Whether these parts of the subject are reproduced sharply or “blurred”, and the degree of “blurring”, is determined by two independent factors:

1. The length of the shutter speed, i.e. for how long these parts of the subject “act upon” the film
2. How quickly these parts of the subject – or the camera itself – are moving during exposure. The longer the shutter speed or the faster this movement, the greater the extent to which the two – superimposed – parts of the picture can differ.



With the flash fired at the normal moment, at the beginning of the exposure, i.e. immediately after the 1st shutter curtain has completely opened, this can even lead to apparent contradictions, such as in the picture of the motorcycle (left), which is being overtaken by its own light traces.

The LEICA M8.2 gives you a choice between this normal flash firing moment and synchronization with the end of the exposure, i.e. immediately before the 2nd shutter curtain begins to close again. In this case, the sharp image is located at the end of the movement. In the photograph (right), this flash technique gives a natural impression of movement and dynamics.



This function is available at all camera and flash unit settings, and in aperture priority mode as well as in manual shutter speed selection, in the various automatic flash modes as well as in manual flash mode; this displays are the same in all cases.

Note:

When using snapshot mode **S** (see p. 96), synchronization with the 1st shutter curtain is a fixed setting.

Setting the function

1. In the main menu (see p. 94/113), select **Flash Sync** (5.1.13) and
2. in the respective sub-menu, select the desired option: **1. Curtain** or **2. Curtain**.

Additional functions

User / application specific profiles

On the LEICA M8.2, any combination of all main and picture parameters menu settings can be permanently stored, e.g. so that they can be retrieved quickly and easily for recurring situations / subjects. A total of three memory slots are available for these combinations - **1 / 2 / 3**

Applying settings / Creating a profile

1. Set the desired functions in the main and picture parameters menus.
2. In the main menu (see p. 94/113), select **Save User Profile** (5.1.2) and
3. in the associated sub-menu select the desired memory slot.

Selecting a saved profile

1. In the picture parameters menu (see p. 95/113) select **User Profile** (5.2.6), and
2. in the associated sub-menu select the desired profile.

Notes:

- In addition to the three memory slots, there is also the **0** setting, which you can use to restore the factory default settings at any time. **User Profile 0** is thus similar to the **Reset** function (see next section) except that it does not delete all settings, specifically retaining those in the other three profiles.
- If you change one of the settings for the profile currently in use, the corresponding figure is cleared.

Resetting all custom settings

This function allows you in one operation to delete all previous user settings in the main and picture parameters menus and reset them to the factory default settings.

Setting the function

1. In the main menu (see p. 94/113), select **Reset** (5.1.16) and
2. use the **SET** button (1.22) to call up the associated sub-menu.
3. Then use the left/right direction button (1.31) to select the desired function, and
4. confirm your selection by pressing the **SET** button once again.

Note:

This reset also affects any individual profiles specified and saved using **Save User Profile** function (5.1.2, see above).

Review mode

As described in the "Selecting picture and review modes" and "Automatic review of last picture" (p. 107) sections, you can view the pictures you have taken in the monitor (1.33) on the LEICA M8.2. Pictures can either be reviewed automatically for a short time immediately after you have taken them in **Auto Review** mode, or at any time for an unlimited period in **PLAY** mode. In both cases, several additional options are available while viewing the pictures.

Notes:

- If no pictures are stored on the card, on pressing the **PLAY** button the following message appears on the monitor: **No image data available**.
- Depending on the function previously set, pressing the **PLAY** button generates different responses:

	Initial situation	After pressing the PLAY button
a.	Full review display of a picture	Picture mode, monitor off
b.	Review of an enlarged section / several reduced pictures (see below) Full review display of the picture	Full review display of the picture
c.	INFO display with any enlargement (see p. 93/141)	INFO display with full review display
d.	One of the menu controls (see p. 113), or DELETE or PROTECT function (see p. 143/144) is activated	Full review display of the last displayed picture

- The LEICA M8.2 stores pictures in line with the DCF standards (Design Rule for Camera File System).
- The LEICA M8.2 can only review pictures taken with cameras of this type.

Additional options when viewing

A. Viewing other pictures / "Scrolling" in the memory

You can open other saved pictures using the left and right direction buttons (1.31). Pressing the left button takes you to the pictures with lower numbers, pressing the right button takes you to those with higher numbers. Holding the button down (approx. 2s) results in fast scrolling. After the highest and lowest numbers, the series of pictures begins again in an endless loop, which means you can reach all pictures in either direction.

- The picture and file numbers in the monitor change accordingly.



B. Enlarging / selecting the section / simultaneous viewing of several reduced pictures

With the LEICA M8.2 it is possible to open an enlarged section of an individual picture in the monitor to study it more closely, with a free choice of section. Conversely, you can also view up to 9 pictures simultaneously in the monitor, e.g. to gain an overview or to find the picture you are looking for more quickly.

Notes:

- The more the picture is enlarged, the more the reproduction quality in the monitor deteriorates – due to the proportionately lower resolution.
- While an enlarged picture is displayed, the direction buttons are no longer available to open other pictures, instead they are used to "navigate" within the picture. (Exception: see next note).

Turning the setting ring (1.30) to the right (clockwise) enlarges the central section. The more you turn the ring, the greater the enlargement and the smaller the section area. Enlargement is possible up to 1:1, i.e. until 1 pixel of the monitor displays 1 pixel of the picture.

- The rectangle within the frame (4.1.3/4.2.6k) in the lower right-hand corner of the monitor symbolizes the current enlargement.



The four direction buttons (1.14) can be used to select any position for the section to be enlarged. To do this, press the button (several times) for the direction in which you want to shift the section.

- In addition to the enlargement, the rectangle within the frame (4.1.3/4.2.6k) in the lower right-hand corner of the monitor symbolizes the position of the section displayed.



Note:

You can also switch from an enlarged picture directly to another picture, which will then be shown at the same enlargement. To do this press the left or right direction button again – keeping the **PLAY** button pressed (1.27).

By turning the setting ring to the left (anticlockwise, starting from normal size), you can simultaneously view 4 – or by turning the ring further – 9 pictures in the monitor.

- Up to 9 reduced images are shown in the monitor (1.33) including the picture previously being viewed at normal size, which is marked with a red border.

You can use the four direction buttons to navigate freely among the reduced images, and the relevant image is marked accordingly. You can then view this image at normal size by turning the setting ring to the right.

Note:

When showing 9 pictures, turning the setting dial further to the right places the red frame around the entire group of pictures, which then allows you to "scroll" more quickly, a block at a time.

C. Deleting pictures

While a picture is displayed in the monitor, you have an opportunity to delete it if you wish to do so. This can be useful, for example if the pictures have already been saved to other media, if you no longer require them or if you need to free up more space on the memory card.

The LEICA M8.2 also offers you the option of deleting single pictures, or all pictures at the same time, as required.

Notes:

- Deletion can be performed only in review mode, albeit irrespective of whether a picture is shown in normal size or several reduced pictures are shown (not however if the 9-block review is shown with a red frame round the entire block, see p. 141).
- For protected pictures, the protection must first be cancelled before they can be deleted (see also next section).

Important:

Deletion of a pictures is permanent. Pictures cannot subsequently be recovered.

Procedure

Press the **DELETE** button (1.25).

- The corresponding sub-menu appears in the monitor display (1.33).



Notes:

- The delete process can be cancelled at any time by pressing the **DELETE** button again.
- The following controls and their functions are not available during the entire delete process: the **MENU** (1.29), **PROTECT** (1.24) and **INFO** (1.23) buttons.

The first step is to decide

- whether you want to protect individual pictures
Delete **Single**,
- or
- all pictures simultaneously
Delete **All**

The subsequent procedure is controlled by the menu, i.e. essentially as described in the “Menu control” section (on p. 113). After specifying the relevant menu display, this is done using the shutter speed setting dial (1.30), the direction buttons (1.31) and the **SET** button (1.22).

Note:

If the picture shown is protected (see p. 144), the **Single** option cannot be selected in the sub-menu.

When deleting all pictures, to prevent accidental deletion there is an intermediate step in which you must reconfirm that you definitely want to delete all pictures on the memory card.

Displays after deleting

Deleting individual pictures

After deleting, the preceding picture appears.

If there are no more pictures saved on the card, the following message appears:

No image data available.

Deleting all pictures on the memory card

After deleting, the following message appears:

No image data available.

However, if one or more pictures were protected, that picture or the first of those pictures then appears.

Note:

When a picture is deleted, the subsequent pictures in the frame counter (4.1.2/4.2.5) are re-numbered as follows: For example, if you delete picture no. 3, what was previously picture no. 4 then becomes no. 3, the previous no. 5 becomes no. 4 etc. However, this does not apply to the file numbering on the memory card (in the **INFO** display, see p. 93) for the remaining image files in the folder (4.2.6j), which remains unchanged.

D. Protecting pictures / Clearing delete protection

The pictures stored on the memory card can be protected against accidental deletion. This protection can then be cleared at any time.

Notes:

- Applying or removing picture protection can be performed only in review mode, irrespective of whether a picture is shown in normal size or as one of several reduced pictures (not however if the 9-block review is shown with a red frame round the entire block, see p. 141).
- For details of the different procedures/responses when you attempt to delete protected pictures, refer to the previous section.
- If you decide you want to delete them, clear the protection as described below.
- Protection is only effective for the LEICA M8.2.
- Even protected pictures are deleted if the memory card is reformatted (see next section for details).
- On SD/SDHC memory cards, you can prevent accidental deletion by sliding the write protection switch on the card (see p. 101) to the position marked **LOCK**.

Procedure

Press the **PROTECT** button (1.24).

- The corresponding sub-menu appears in the monitor display (1.33).



Notes:

- The setting process can be cancelled at any time by pressing the **PROTECT** button again.
- The following controls and their functions are not available during the entire setting process: the **MENU** (1.29), **DELETE** (1.25) and **INFO** (1.23) buttons

The subsequent procedure is controlled by the menu, i.e. essentially as described in the “Menu control” section (on p. 113). After specifying the relevant menu display, this is done using the shutter speed setting dial (1.30), direction buttons (1.31) and the **SET** button (1.22).

The first step is to decide

- whether you want to protect individual pictures

Protect Single

or

- all pictures simultaneously

Protect All

or

- whether you want to clear the existing protection for individual pictures

Clear Protection Single

or

for all pictures

Clear Protection All

Note:

The following functions cannot be performed and the menu text appears in white instead of black to indicate this:

- Protecting a picture that is already protected, or if all pictures are already protected.
- Unprotecting a picture that is already unprotected, or if no pictures are already protected.

Displays after protection / clearing protection

After leaving menu control, the original monitor display appears again, with the corresponding symbol  for protected pictures (4.1.1/4.2.3).

Note:

The  symbol also appears if a picture that is already protected is opened.

Additional functions

Changing the picture numbering

The LEICA M8.2 assigns pictures sequential picture numbers, in the default factory setting regardless of whether the memory card is changed. You can at any time specify that

- a. the numbering sequence begins afresh every time the memory card is changed, or
- b. the numbering sequence starts immediately, e.g. to assign picture number to different events, subjects etc.

Setting the function

1. In the main menu (see p. 94/ 113), select **Picture Numbering** (5.1.10) and
2. and in the associated sub-menu select the desired function.

Depending on the selected function, the file numbering starts again from 1 either after the next change of memory card - **Default** - or from the next picture - **Reset Now**.

Notes:

- The change of numbering relates exclusively to the file names, e.g. **L100 0001**, which are only shown in the **INFO** display (see p. 93).
- After the memory card has been formatted, the **Reset folder no. now** sub-menu can be used to reset the folder number also

Formatting the memory card

It is not normally necessary to format (initialize) a memory card that has already been used. If however a card that has yet to be formatted is inserted for the first time, it must be formatted. In such cases the **Format SD-Card** sub-menu appears automatically.

Nevertheless, it is recommended that the memory card be reformatted occasionally, as a certain amount of residual data (info accompanying pictures) can take up memory capacity.

Important:

When formatting, all information present on the card, including picture files and all other data, e.g. music files, is irretrievably lost. You should therefore get into the habit of transferring all your pictures onto a secure bulk storage medium, e.g. the hard drive on your computer, as soon as possible.

Notes:

- Do not turn the LEICA M8.2 off while the memory card is being formatted.
- If the memory card has been formatted in another device, such as a computer, you should reformat it in the LEICA M8.2.
- If the memory card cannot be formatted, you should ask your dealer or Leica Information Service (address, see p. 165) for advice.
- Even protected pictures (see previous section) are deleted when formatting the memory card.

Procedure

1. In the main menu (see p. 94/ 113), select **Format SD-Card** (5.1.22).
2. Use the **SET** button (1.22) to call up the associated sub-menu.
3. To guard against unintentional settings, you then have to confirm in the corresponding sub-menu using the right direction button (1.31) that you definitely want to format the memory card.

Taking photographs with the self timer

You can use the self timer to take a picture with a delay of either 2 or 12s. This can be particularly useful, for example in the first case if you want to avoid the picture being out of focus due to camera shake when releasing the shutter or, in the second case, for group photographs where you want to appear in the picture yourself. In such cases, we recommend that the camera is placed on a tripod.

Setting and using the function

1. Set the main switch (1.19) to .
2. In the main menu (see p. 94/113) select **Selftimer** (5.1.3), and in the associated sub-menu select the desired delay time.

3. To start the delay time press the shutter release button (1.20) to the first pressure point, see p. 108).
 - The LED (1.7) on the front of the camera flashes for the first 10s of a 12s delay time, then it stays lit continuously, to show the progress of the delay time. The countdown is shown on the monitor at the same time.

While the self timer delay time is running, it can be aborted at any time by pressing the **SET** button (1.22) – the relevant setting is retained and the function can be restarted by touching the shutter release button again.

Important:

In self timer mode, the exposure is not set by depressing the shutter release button to the pressure point, it is set immediately before the picture is taken.

Transferring data to a computer

The LEICA M8.2 is compatible with the following operating systems:

Microsoft®: Windows® XP / Vista®

Apple® Macintosh®: Mac® OS X (10.5)

The LEICA M8.2 is equipped with a USB 2.0 interface for transferring data to a computer. This allows fast data transfer to computers with the same kind of interface. The computer used must have either a USB port (for direct connection to the LEICA M 8.2) or a card reader for SD/SDHC cards.

Note:

When using a USB connection, note the following: Connecting two or more devices to a computer or connecting using a hub or extension cables can result in malfunctions.

Connecting and transferring data with

Windows® XP / Vista®

1. Use the USB cable supplied (C) to connect the USB socket (1.34) on the LEICA M8.2 to a free USB port on the computer. To do this, first open the flap (1.26) over the socket on the camera downwards.

With Windows® XP

- After connecting, a message appears on the desktop to confirm that the LEICA M8.2 has been detected as new hardware (1st connection only!).
2. Double-click on the message (not required after the 1st connection).
 - A pull-down menu entitled “M8.2 Digital Camera” opens for the data transfer wizard.
 3. Click on “OK” and follow the subsequent instructions in the wizard to copy the pictures to a folder of your choice and access them in the normal way.

With Windows® Vista®

- After connection, a message about installation of the device driver software appears above the taskbar. At the same time **USB connected** appears on the camera display. Successful installation is confirmed by another message. The “Automatic Review” menu opens with various device options.
2. You can use the Windows wizard to “Import Images” or “Open Device to View Files” in the normal way to
 3. access the card directory structure using Windows® Explorer.

Connecting and transferring data with

Mac® OS X (10.5)

1. Use the USB cable supplied (C) to connect the USB socket (1.34) on the LEICA M8.2 to a free USB port on the computer. To do this, first open the flap (1.26) over the socket on the camera downwards.
 - Once the camera has been successfully connected to the computer, **USB Connected** appears on the camera display.
2. Now open the “Finder” on the computer.
3. In the left window, click on “Programs” in the “Locations” category.
4. Now select the “Digital Images” program in the right window.
 - The program opens and the name “M8 Digital Camera” appears in the program title bar.
5. The pictures can now be saved on the computer using the “Load” button.

Important:

- Only use the USB cable (C) supplied.
- While data is being transferred from the LEICA M8.2 to the computer, the connection may not under any circumstances be broken by removing the USB cable, as otherwise the computer and/or the LEICA M8.2 may crash, and the memory card may even be irreparably damaged.
- The LEICA M8.2 cannot be turned off or automatically switch itself off due to a lack of battery power while data is being transferred from the camera to the computer, as this may cause the computer to crash. For the same reason the battery must never be removed from the camera while the connection is active. If the battery capacity runs short during data transfer, the corresponding symbol flashes (, see p. 92/100). In this case, stop the data transfer, switch off the LEICA M8.2 (see p. 106) and charge the battery (see p. 98).

Connecting and transferring data using card readers

The picture files can also be transferred to other computers using a standard card reader for SD/SDHC memory cards. Card readers with a USB interface are available for computers with a USB interface. If your computer is equipped with a PCMCIA slot (common on portable models), plug-in cards with a PCMCIA connection are available as an alternative. These devices, and further information about them, is available from a computer accessory dealer.

Note:

The LEICA M8.2 is fitted with a built-in sensor, which detects the position of the camera – horizontal or vertical (both directions) – for each picture. This information automatically allows the pictures to be presented upright when subsequently displayed on a computer running the appropriate programs.

Data structure on the memory card

When the data stored on a card is transferred to a computer, the following folder structure is used:

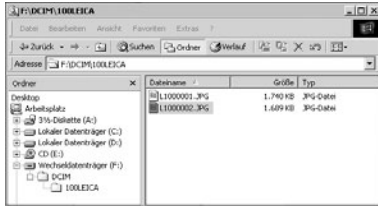

Up to 9999 pictures can be stored in each of the folders 100LEICA, 101LEICA etc.

Working with DNG raw data

If you have selected the standardized and future-proof DNG (Digital Negative) format, you require highly specialized software to convert the saved raw data into optimum quality, for example the professional Capture One 4 raw data converter from Phase One. This software can be found on the DVD-ROM (F) that is supplied with the LEICA M8.2. Capture One 4 provides quality-optimized algorithms for digital color processing, simultaneously allowing you to produce low-noise pictures with outstanding resolution.

During editing, you have the option of adjusting parameters such as white balance, noise reduction, gradation, sharpness etc. to achieve an optimum image quality.

Installing Capture One 4

To start the installation, you must register your copy of the software on the Phase One homepage.

Notes:

- Have the required license code to hand – this is printed on the paper sleeve containing the DVD-ROM.
- You also require a valid e-mail address to activate the software.
- The software can only be used for the 30-day trial period without the license code.

1. The first time you start Capture One, select “Activation”, and
2. enter the license code in the relevant field.
3. Follow the subsequent instructions.

During activation, a profile is created for the user on the Phase One license server. This allows you to re-activate a license after previously deactivating it, for example if you want to install the software on a different computer.

Notes:

- If you need help, click on the “Help” button to open up a window containing the Capture One 4 manual, where you can find a description of the activation and deactivation process. The first time you start Capture One 4, it opens in English. You can change the language setting to the language of your choice by selecting “Edit – Preferences” in the menu.
- If you require support when using Capture One 4, call up the following page:
<http://www.phaseone.com/Support> and log in with your “Phase One Profile” that was created when activating the software.

System requirements

Microsoft® Windows® XP Professional or Home Edition with Service Pack 2 / Vista®; Mac® OS X 10.4.11 or later
On some Windows® versions, it is possible that the operating system will issue a warning about a missing Windows signature. Ignore this message and continue with the installation.

Installing firmware updates

Leica is constantly working on developing and optimizing its products. As digital cameras have many functions that are controlled electronically, some of these improvements and enhancements to the functions can be installed on the camera at a later date.

To do this, Leica provides firmware updates at irregular intervals, which you can easily download from our homepage to your camera yourself:

1. Format a memory card in your LEICA M8.2.
2. Turn off the camera and insert the card into an SD/SDHC card reader – either integrated or connected to your computer. (A reader is required for Firmware updates).
3. Download the Firmware file from the Leica M8.2 site using the “UPDATES” link.
4. Save the file m8-2_0xx.upd at the top level of the card folder structure. The xx stands for the relevant version.

5. Remove the card properly from your card reader, insert the card into the camera and close the bottom cover. Turn on the camera using the main switch.
6. Confirm the prompt that appears in the monitor as to whether you want to update the Firmware on the camera to version 2.xx.

The update process takes around 180s. You will then be prompted to restart the camera using the main switch.

7. Turn the camera off and back on again.

Note:

If the battery does not have sufficient charge, you will see a corresponding warning message.

Miscellaneous

System accessories for the LEICA M8.2

Exchangeable lenses

The Leica M system provides a basis for optimum adaptation to fast and unobtrusive photography. The range of lenses includes focal lengths from 16 to 135 mm – for the LEICA M8.2 this corresponds to effective focal lengths from 21 to 180 mm (bright-line frames for focal lengths =90 mm (effective) are unavailable, see also p. 34) and a light intensity of up to 1:1.

Filters

UVa filters and circular polarization filters are available for current Leica M lenses equipped with standard filter threads.

There are also special UV/IR filters to ensure neutral color reproduction in all situations (see “Using Leica UV/IR filters to correct color shifts for particular subjects and lighting situations”, p. 103).

Universal Wide-Angle Viewfinder M

The LEICA Universal Wide-Angle Viewfinder M is a thoroughly practical accessory. It can be used without restriction on all analog and digital Leica M models and shows – just like the viewfinder in the camera – with a reflected bright-line frame the picture area for wide-angle focal lengths 16, 18, 21, 24 and 28 mm.

The viewfinder is equipped with parallax compensation and a vial (spirit level) for exact leveling of the camera (order no. 12 011).

Viewfinder magnifier M 1.25x and M 1.4x

The LEICA M 1.25x and M 1.4x viewfinder magnifiers significantly simplify picture composition when using focal lengths above 35 mm. They can be used on all Leica M models and magnify the central area of the viewfinder image. The 1.25x viewfinder magnifier gives the 0.68x viewfinder on the LEICA M8.2 a magnification of 0.85x, while the 1.4x gives 0.95x magnification.

A security chain with snap fasteners prevents loss and can be used to hang the magnifier on the carrying strap's fastening ring.

The magnifiers are supplied in a leather bag. A loop on the bag allows the magnifier to be stored on the camera's carrying strap, where it is protected and ready for use (order no. 12 004 for M 1.25x, 12 006 M 1.4x).

Handgrip M8

As a practical accessory, we recommend the Handgrip M8, which allows you to hold the LEICA M8.2 extremely steadily and to carry it with one hand. It is attached in place of the standard bottom cover. (order no. 14 486 black, 14 487 silver).

Correction lenses

For optimum adaptation of the eye to the camera's viewfinder, we offer correction lenses with the following positive or negative diopter values (spherical): 0,5/1/1,5/2/3.

Cases

There are two neoprene cases for the LEICA M8.2 with different front sections for lenses of different lengths, a classic leather case and a protector that is similar to the lower section of a traditional case. This protector reliably protects the camera body, even when taking photographs (order no. 14 867 short, 14 868 long, 14 872 leather, 14 869 protector).

For your full set of camera equipment, the classic Billingham combination case made of waterproof fabric is also available. This either holds two cameras and two lenses or one camera and three lenses. There is enough space for large lenses and for a camera with a LEICAVIT-M or LEICA MOTOR-M attached. A Velcro fastened compartment provides additional space for a LEICA SF 24D flash and other accessories (order no. 14 854 black, 14 855 khaki).

Spare parts	Order no.
Camera bayonet cap	14 195
Carrying strap	14 312
Lithium ion battery	14 464
Compact charger (with EU/USA mains cables, in-car charging cable)	14 470
Mains cable for AUS and UK	14 422 / 14 421
USB cable (2 m, 4 to 6 pin)	420-200.023-000

Precautions and care instructions

General precautions

Do not use the LEICA M8.2 in the immediate vicinity of devices with powerful magnetic, electrostatic or electromagnetic fields (e.g. induction ovens, microwave ovens, television sets or computer monitors, video game consoles, cell phones, radio equipment).

- If you place the LEICA M8.2 on or very close to a television set, its magnetic field could interfere with picture recordings.
- The same applies for use in the vicinity of cell phones.
- Strong magnetic fields, e.g. from speakers or large electric motors, can damage the stored data or the pictures.
- If due to the effects of electromagnetic fields the LEICA M8.2 malfunctions, remove the battery and then switch the camera on again.

Do not use the LEICA M8.2 in the immediate vicinity of radio transmitters or high voltage power lines.

- Their magnetic fields can also interfere with picture recordings.

Protect the LEICA M8.2 from contact with insect sprays and other aggressive chemicals. Petroleum, thinner and alcohol may not be used for cleaning.

- Certain chemicals and liquids can damage the LEICA M8.2 body or the surface finish.
- As rubber and plastics sometimes emit aggressive chemicals, they should not remain in contact with the LEICA M8.2 for extended periods.

Ensure that sand and dust cannot get into the LEICA M8.2, e.g. on the beach.

- Sand and dust can damage the camera and the memory card. Take particular care when changing lenses and when inserting and removing the card.

Ensure that water cannot get into the LEICA M8.2, e.g. when it is snowing or raining and on the beach.

Moisture can cause malfunctions and even permanent damage to the LEICA M8.2 and the memory card.

If salt water spray gets onto the LEICA M8.2, wet a soft cloth with tap water, wring it out thoroughly and wipe the camera with it. Then wipe down thoroughly with a dry cloth.

LCDs

- If the LEICA M8.2 is exposed to significant temperature fluctuations, condensation can form on the monitor. Wipe it carefully with a soft dry cloth.
- If the LEICA M8.2 is very cold when it is switched on, the LCDs may at first appear darker than usual. As soon as the camera warms up, the LCDs will regain their normal brightness.

The monitor is manufactured using a high-precision process. This ensures that, of the total of around 230,000 pixels, more than 99.995% work correctly and only 0.005% remain dark or are always light. However, this is not a malfunction and it does not impair the reproduction of the picture.

Sensor

Cosmic radiation (e.g. on flights) can cause pixel defects.

Condensation

If condensation has formed on or in the LEICA M8.2, you should turn it off and leave it to stand at room temperature for around an hour. Once the camera temperature has adjusted to room temperature, the condensation will disappear by itself.

Care instructions

- As any soiling also represents a growth medium for microorganisms, you should take care to keep the equipment clean.

For the camera



- Only clean the LEICA M8.2 with a soft, dry cloth. Stubborn dirt should first of all be covered with a well-thinned cleaning agent and then wiped off with a dry cloth.
- To remove stains and fingerprints, the camera and lens should be wiped with a clean lint-free cloth. Tougher dirt in hard to reach corners of the camera body can be removed with a small brush. Be careful not to damage the shutter blades, for instance with the shaft of the brush.
- All mechanically operated bearings and sliding surfaces on your LEICA M8.2 are lubricated. Please remember this if you will not be using the camera for a long period of time. To prevent the lubrication points becoming gummed up, the camera shutter should be released a number of times every three months. It is also recommended that you repeatedly move and use all other controls, such as the image field selector. The distance and aperture setting rings on the lens should also be moved periodically.
- Take care not to scratch the sensor for the 6-bit coding (1.10) in the bayonet, or to get it dirty. Take care also that no grains of sand or similar particles are lodged there, because they could scratch the bayonet. Never wet this component when cleaning it!

For lenses

- Normally, a soft hair brush is sufficient to remove dust from the outer lens elements. However, in case of more stubborn dirt, they can be carefully cleaned with a very clean, soft cloth that is completely free of foreign matter, using circular motions from the inside to the outside. We recommend micro-fiber cloths (available from photographic and optical specialists) that are stored in a protective container and can be washed at temperatures of up to 40°C (without fabric softener, never iron!). Cloths for cleaning glasses, which are impregnated with chemicals, should not be used as they can damage the lens glass.
- Take care not to scratch the 6-bit coding (1.11) in the bayonet fastening, or to get it dirty. Take care also that no grains of sand or similar particles enter the fastening, where they could scratch the bayonet. Never wet this component when cleaning it!
- For optimum front lens protection in unfavorable photographic conditions (e.g. sand, salt water spray), use transparent UVA filters. However, you should bear in mind that, like all filters, they can cause unwanted reflections in certain backlight situations and with high contrasts. The generally recommended lens hood also protects the lens from unintentional fingerprints and the rain.

For the battery

Rechargeable lithium ion batteries generate power through internal chemical reactions. These reactions are also influenced by the external temperature and humidity. Very high or low temperatures reduce the life of the battery.

- Always remove the battery if you will not be using the LEICA M8.2 for a long period of time. Otherwise, after several weeks the battery could become totally discharged, i.e. the voltage is significantly reduced, as the LEICA M8.2 uses a low no-load current (to save the date) even when it is turned off.
- Lithium ion batteries should be stored only in the partially charged condition (the top panel LCD [1.12] shows a value in the range  to ). For very long storage periods, it should be charged up and discharged again around once a year.
- Always ensure that the battery contacts are clean and freely accessible. While lithium ion batteries are proof against short circuits, they should still be protected against contact with metal objects such as paper clips or jewelry. A short-circuited battery can get very hot and cause severe burns.
- If a battery is dropped, check the casing and the contacts immediately for any damage. Using a damaged battery can damage the LEICA M8.2.

- Batteries have only a limited service life.
- Take damaged batteries to a collection point to ensure correct recycling.
- Never throw batteries into a fire as this can cause them to explode.

For the charger

- If the charger is used in the vicinity of radio receivers, it can interfere with the reception; make sure there is a distance of at least 1m between the devices.
- When the charger is in use, it can make a noise (buzzing) – this is quite normal and is not a malfunction.
- When it is not in use, disconnect the charger from the mains as otherwise it uses a certain (very small) amount of power even when no battery is inserted in it.
- Always keep the charger contacts clean, and never short circuit them.

For memory cards

- While a picture is being stored or the memory card is being read, it may not be removed, nor may the LEICA M8.2 be turned off or exposed to vibrations.
- For safety, memory cards should only ever be stored in the antistatic cover supplied.
- Do not store memory cards where they will be exposed to high temperatures, direct sunlight, magnetic fields or static discharge.
- Do not drop or bend a memory card as this can damage it and result in loss of the stored data.
- Always remove the memory card if you will not be using the LEICA M8.2 for a long period of time.
- Do not touch the connections on the rear of the memory card and keep them free of dirt, dust and moisture.
- It is recommended that the memory card be reformatted from time to time, as fragmentation occurs when deleting, which can block some of the memory capacity.

Cleaning the sensor

If any dust or dirt particles should adhere to the sensor cover glass, depending on the size of the particles this can be identified by dark spots or marks on the pictures.

The LEICA M8.2 can be sent to Leica Camera AG's Customer Service for the sensor to be cleaned at a cost (address: see p. 165) – this cleaning is not included in the warranty. You can also perform the cleaning yourself, using the menu function **Sensor Cleaning**. This allows access to the sensor by keeping the shutter open.

Notes:

- To protect the LEICA M8.2 against ingress of dust etc. into the interior of the camera, it is important always to have a lens or a cap attached to the camera body.
- For the same reason, when changing lenses work without delay and in an environment that is as dust-free as possible.

Setting the function

1. In the main menu (see p. 94 / 113), select **Sensor Cleaning** (5.1.17) and
 - The respective sub-menu appears.
2. Providing the battery has sufficient capacity, i.e. at least 60%, confirm the function in the sub-menu.
 - A further sub-menu will appear

Note:

If however the battery has insufficient capacity, the warning message **Attention Battery too low for sensor cleaning** appears instead, indicating that the function is not available, i.e. **Yes** cannot be selected

3. Press the shutter release button (1.20). The shutter opens and remains open.

Perform the cleaning. Scrupulously comply with the following instructions:

Notes:

- As far as possible, both inspection and cleaning of the sensor should be performed in a dust-free environment to prevent further soiling.
- An 8x or 10x magnifying glass is very useful for the inspection and after cleaning.
- Lightly adhering dust can be blown off the sensor cover glass using clean and, if necessary ionized gases such as air or nitrogen. It makes sense to use a (rubber) bellows with no brush for this purpose. Special, low pressure cleaning sprays such as "Teternal Antidust Professional" can also be used in line with their specified usage.

- If the particles cannot be removed from the sensor in this way, please refer the matter to your Leica Information Service (address: see p. 165).
- If the battery capacity falls to less than 40 % while the shutter is open, a warning message **Attention Battery low Switch off camera** will appear on the monitor. At the same time a sustained beep tone will sound, which continues until the camera is switched off. Switching the camera off will cause the shutter to be closed again. Be absolutely sure in this case that the shutter window is clear, i.e. that no object can obstruct the closing movement of the shutter, otherwise damage may occur!

Important:

- Leica Camera AG accepts no liability for damage caused by the user when cleaning the sensor.
- Do not attempt to blow dust particles off the sensor cover glass using your mouth; even tiny droplets of saliva can cause marks that are difficult to remove.
- Compressed air cleaners with high gas pressure may not be used as they can also cause damage.
- Take care to avoid touching the sensor surface with any hard objects during inspection and cleaning.

Storage

- If you are not using the LEICA M8.2 for an extended period of time, we recommend that you:
 - a. switch it off (see p. 106),
 - b. remove the memory card (see p. 101) and
 - c. remove the battery (see p. 100) (after a maximum of 3 months, the time and date will be lost, see p. 116).
- A lens works like a magnifying glass if bright sunlight shines on the front of the camera. The camera must therefore never be set aside in strong sunlight without protection. Use the lens cover and keep the camera in the shade (or immediately put it away in the case) help to prevent damage to the interior of the camera.
- You should preferably store the LEICA M8.2 in a closed and padded container so that nothing can damage it and it is protected from dust.
- Store the LEICA M8.2 in a dry, adequately ventilated place, where neither high temperatures nor high humidity will occur. When used in humid conditions, the LEICA M8.2 should be completely cleared of all moisture before being stored away.
- Photo cases that became wet during use should be emptied to prevent damage to your equipment caused by moisture and any leather-tanning residue released.

- To prevent fungal growth during use in hot, humid tropical climates, the camera equipment should be exposed to the sun and air as much as possible. Storage in airtight containers or cases is recommended only if a desiccant such as silica gel is placed in the container.
- To prevent the formation of fungus, do not store the LEICA M8.2 in a leather case for extended periods of time.
- Note the serial numbers of your LEICA M8.2 (en- graved on the accessory shoe) and lenses, as these are extremely important in case of loss.

The warning messages

Bottom cover removed

Close the bottom cover (see p. 100).

No memory card

Insert a memory card (see p. 101).

SD card full

Insert another memory card (see p. 101) or delete pictures you no longer need (see p. 143).

Memory card protected

(protected against deletion)

Reset the write protection for the memory card (see p. 101).

No image data available.

No pictures are saved on the inserted card.

In order for review mode to be used, pictures first of all need to be taken or another card with saved pictures inserted (see p. 101).

Data transmission

Picture data is currently being transferred to the SD/SDHC card.

All other picture processing functions are unavailable while this is in progress.

Error code XX

Please ask your Leica dealer or Leica agent for your country regarding this information (addresses are shown on the Warranty Card).

Malfunctions and their resolution

1. The LEICA M8.2 does not respond when I turn it on.

- 1.1 Has the battery been correctly inserted?
- 1.2 Does the battery have sufficient charge?
Use a charged battery.
- 1.3 Has the bottom cover been correctly fitted?

2. The LEICA M8.2 turns itself off again as soon as I turn it on.

- 2.1 Does the battery have sufficient charge to operate the LEICA M8.2?
Charge the battery or insert a charged battery.
- 2.2 Is there any condensation? This can occur if the LEICA M8.2 is moved from a cold place to a warm place.
Wait until the condensation clears.

3. The LEICA M8.2 shutter refuses to trip.

- 3.1 Picture data are currently being transferred to the memory card and the intermediate memory is full.
- 3.2 The capacity of the memory card is exhausted and the intermediate memory is full. Delete pictures you no longer require before taking new ones.
- 3.3 No memory card has been inserted and the intermediate memory is full.

4. I cannot save the picture.

- 4.1 Is a memory card inserted?
- 4.2 The capacity of the memory card is full.
Delete pictures you no longer require before taking new ones.

5. The monitor is too dark or too bright.

- 5.1 When viewing the monitor image from wide angles it is always more difficult to see. If it is too pale or too dark although you are looking at the monitor full on: Select a different brightness¹.

6. The picture I have just taken is not shown in the monitor

- 6.1 Is the Auto Review function active (when setting the LEICA M8.2 to picture mode)?²

7. I cannot display the picture.

- 7.1 Is a memory card inserted?
- 7.2 The memory card does not contain any data.

8. Despite being connected to a computer, I cannot transfer any data.

- 8.1 Check whether the computer and the camera are connected correctly.

9. The date and time displays show incorrect values or are blank.

- 9.1 The LEICA M8.2 has not been used for a long period, particularly if the battery has been removed.
 - 1. Insert a fully charged battery.
 - 2. Set the date and time.

¹ Not possible in snapshot mode **S**

² Always active in snapshot mode **S**

Accessories	
Cases	152
Correction lenses	152
Exchangeable lenses	152
Filters	152
Handgrip M8	152
Universal wide-angle viewfinder M	152
Viewfinder magnifier M 1.25x / M 1.4x	152
Aperture priority mode	128
Aperture setting ring	90
Battery	
Charge level displays	92/100
Charging	98
Insertion / removal	100
Bright-line view and range finder	124
Care instructions	154
Carrying strap	98
Cases	152
Color saturation, see image properties	
Compression rate	141
Contrast, see image properties	
Correction lenses	152
Data structure on the memory card	150
Deleting pictures	143
all pictures on the memory card	143
single pictures	143
Designation of parts	90
Depth of field scale	90
Displays	
In the top panel LCD	92
In the viewfinder	92
On the monitor	93
Distance setting	126
Depth of field	105
Metering field	126
Range finder	126
Sensitivity	121/133/132
Setting	121
Setting ring	90
Split image method	126
Superimposed image method	126
Enlarge, see review mode and viewing pictures	
Exchangeable lenses	101/152
Exposure / Exposure meter	127
Aperture priority	128
Manual setting	131
Metering range	132/133
Metering diagram	133
Working below the metering range	132
Sensitivity	121/133/132
Snapshot mode S	96
Switching off	127
Switching on	127
Exposure compensation	129
Filters	152
Firmware downloads	151
Flash operation	134
Synchronization	137/138
Formatting the memory card	146
Histogram	112
Holding the camera correctly	123
Image field selector	124
Image frequency	109

Image properties	Section, Selection of, see review mode	141 / 140	Volume, setting the button acknowledge
(contrast, sharpness, color saturation)	Self timer	147	(response) tones
Information service, Leica.....	Series exposures	109	Warning messages
Internet / Leica homepage	Sharpness, see image properties		White balance.....
ISO sensitivity	Shutter release button, see Shutter and Technical		
Lenses, Leica M.....	Data	108 / 162	
Attaching and removing	Shutter speed/aperture combination, see Exposure		
Structure.....	setting and Metering diagram		
Use of older lenses	Shutter speed setting dial	110	
Main switch	Snapshot mode S	96	
Malfunctions and their resolution	Sounds (button acknowledge (response) tones).....	117	
Memory card, inserting and removing	Spare parts	153	
Menu items	Storing the LEICA M8.2	157	
.....	Switch off, automatic.....	106	
Menu language	Switching on / off.....	106	
Menu control	Technical Data	162	
Metering diagram	Time and date	124 / 125	
Monitor	Transferring data to a computer.....	148	
Setting the brightness	USB connection	148	
Noise reduction.....	UV/IR filters	103	
.....	Viewfinder.....	124	
Parts, designation.....	Bright line frame	124 / 125	
Protecting pictures / Clearing delete protection ..	Detachable viewfinders.....		
Raw data	Universal wide-angle viewfinder M	152	
Record and review modes.....	Viewfinder magnifier M 1.25x / M 1.4x	152	
Repairs / Leica Customer Service	Displays	92	
Resetting all custom menu settings	Viewing the picture (in record mode,		
Resolution	immediately after taking)		
Review mode	with the Auto Review function		
Enlarging	(automatic review).....	107	
Four / nine single pictures simultaneously	with the PLAY function	107 / 140	
Selecting the trimming			
Single pictures			
Scope of delivery			

Technical data and descriptions

Camera type Compact digital view and rangefinder system camera.

Lens attachment Leica M bayonet with additional sensor for 6-bit coding.

Lens system Leica M lenses from 16 to 135 mm

Picture format / image sensor 3936 x 2626 pixels (10.5 MPixel) CCD chip, active area 18 x 27 mm, extension factor 1.33.

Resolution Adjustable, DNG™: 3916 x 2634, JPEG: 3936 x 2630 / 2952 x 1972 / 1968 x 1315 / 1312 x 876 Pixel.

Data formats DNG™ (raw data), 2 JPEG compression levels.

File size DNG™: 10.3131 MB, JPEG: 10.35 / 5.8 / 2.5 / 1.1 MB.

Color spaces Adobe® RGB, sRGB, ECI RGB.

White balance Automatic, manual, 6 presets, color temperature entry.

Storage medium SD cards up to 4GB / SDHC cards up to 32GB, larger SD cards with firmware update.

Menu languages German, English, French, Spanish, Italian, Japanese, Chinese.

Compatibility Windows® XP / Vista®; Mac® OS X (10.5)

Exposure metering Exposure metering through the lens (TTL), heavily center-weighted with working aperture. Center-weighted TTL metering for flash lighting with system-compatible SCA-3000/2 standard flash units.

Measurement principle measured by light reflected by a bright blade in the first shutter curtain.

Metering range (for ISO 160/23°) At room temperature and normal humidity EV 0 to 20, or f/1.0 and 1.2s to f/32 and 1/1000s. Flashing of the left triangular LED in the viewfinder indicates values below the metering range.

Measurement cell for available light (continuous light measurement) silicon photo diode with collecting lens, positioned at the center lower edge, on the camera bottom.

Film speed range ISO 160/23°, 320/26°, 640/29°, 1250/32° or ISO 2500/35°, In aperture priority **A** and manual exposure modes, choice of automatic control or manual setting, in snapshot mode **S** automatic control.

Exposure mode Choice of automatic shutter speed control with manual aperture selection – with display of correct exposure or tendency towards overexposure/ blurring in snapshot mode **S** or corresponding digital display for aperture priority **A**, or manual shutter speed and aperture setting and compensation using LED light balance.

Flash exposure control

Flash unit connection via accessory shoe with central and control contacts.

Synchronization Optionally triggered at the first or second shutter curtain.

Flash synchronization speed = $1/180$ s; slower shutter speeds possible.

Flash exposure metering (with SCA-3501/3502 adapter or SCA-3000 standard flash unit such as LEICA SF 24D). Control with center-weighted TTL-pre-flash metering.

Flash measurement cell: 2 silicon photo diodes with collecting lens on the camera bottom.

Flash exposure compensation $\pm 3 \frac{1}{3}$ EV in $\frac{1}{3}$ EV steps settable on the SCA-3501/3502 adaptor. On the LEICA SF 24D ± 3 EV in $\frac{1}{3}$ EV steps or 0 to -3 EV in 1EV steps can be set using computer control.

Displays in flash mode Readiness: by the flash symbol LED in the viewfinder being constantly lit; confirmation of success: By the LED remaining lit or flashing rapidly for a while after taking the picture; under-exposure display by the LED going out for a while.

Viewfinder

Viewfinder principle Large, bright-line frame viewfinder with automatic parallax compensation.

Eyepiece: Adjusted to -0.5 dptr. Correction lenses from -3 to $+3$ dpt. available.

Image field limits By activating two bright-line frames each: For 24 and 35 mm, or for 28 and 90 mm, or for 50 and 75 mm. Automatic activation when lens is attached. Any desired pair of bright-line frames can be activated using the image field selector.

Parallax compensation The horizontal and vertical difference between the viewfinder and the lens is automatically compensated according to the relevant distance setting, i.e. the bright-line frames automatically align with the subject detail recorded by the lens.

Matching of viewfinder and actual picture The size of the bright-line frame corresponds to the sensor size of 18 x 27mm at a setting distance of 2 meters. At infinity setting, depending on the focal length, approx. 7,3 % (24 mm) to 18 % (90 mm) more of the view is recorded by the sensor than indicated by the corresponding bright-line frame and slightly less for shorter distance settings than 2 m.

Enlargement (for all lenses) 0.68x.

Large base range finder Split or superimposed image range finder shown as a bright field in the center of the viewfinder image.

Effective measurement base 47.1 mm (mechanical measurement basis 69.25 mm x viewfinder enlargement 0.68x).

Displays

Viewfinder (lower edge) LED symbol for flash status. Four-digit seven-segment digital display with dots above and below, display brightness adjusted for ambient brightness, for: Warning of exposure compensation, display for automatically generated shutter speeds in aperture priority mode, indication of use of metered value storage, Warning that the metering or setting ranges are overshot or undershot using aperture priority and counting down exposure times longer than 2s.

LED light balance with two triangular and one central circular LED for manual setting of exposures. The triangular LEDs give the direction of rotation of the aperture setting ring and shutter speed setting dial to adjust the exposure. Also for warning of when the metering range is overshot or undershot.

On the top panel monochrome LCD for frame counter (number of pictures remaining) and battery status (5-step).

On the rear panel 2.5" monitor (color TFT LCD) with 230,000 pixels, exceptionally scratch-resistant sapphire glass cover, displays see p. 93.

Shutter and release

Shutter Microprocessor-controlled, exceptionally low-noise metal blade focal plane shutter with vertical movement.

Shutter speeds In snapshot **S** and aperture priority mode (**A**) continuously from 32s to $1/4000$ s. Using manual setting 6 s to $1/4000$ s in half steps, **B** for long exposures of any duration (together with self timer **T** function, i.e. first release = shutter opens, second release = shutter closes), ($1/180$ s) shortest shutter speed for flash synchronization.

Shutter cocking Using low-noise integral motor, optionally after releasing the shutter release button.

Series exposures Approx. 2 pictures/s, approx. 10 pictures in series.

Shutter release button three steps: Exposure metering on – Metering memory lock (in aperture priority mode) – Shutter release. Integrated standard cable release thread.

Self timer Delay optionally 2 (aperture priority and manual exposure setting) or 12s (menu setting), indicated by flashing LED on front of camera and corresponding display on the monitor.

Switching the camera on / off using the main switch on the camera top panel, selectable automatic switch-off of the camera electronics after about 2/5/10 minutes, reactivation by touching the shutter release.

Power supply 1 lithium ion battery, nominal voltage 3.7V, capacity 1900mAh. Capacity data is shown in the display on the left of the top panel, when the shutter is held open (for sensor cleaning); in addition, low capacity is indicated by an acoustic warning.

Charger Inputs: 100-240 V AC, 50/60Hz, automatic switching, or 12/24V DC; Output: 4.2V DC, 800mA.

Camera housing

Material All-metal body of magnesium die-casting, KTL dip painted, synthetic leather covering. Top panel and bottom cover brass, black lacquered or silver chromium plated.

Image field selector Allows the bright-line pairs to be manually displayed at any time (e.g. to compare detail).

Tripod socket stainless steel $1/4$ " DIN tapped socket in bottom cover, in line with the center of the lens.

Operating conditions 0 to +40°C

Interface 5-pin mini-USB 2.0 High-Speed socket for quick data transfer.

Dimensions (width x depth x height) 138.6mm x 36.9mm x 80.2mm

Weight 600g (incl. battery)

Scope of delivery Charger 100-240V with 2 mains cables (Euro, USA, different in some export markets) and 1 in-car charging cable, lithium ion battery, USB cable, carrying strap, DVD-ROM with Capture One 4 from Phase One

Subject to changes to design, manufacture and range.

Leica Academy

As well as outstanding high-performance products for taking, reproducing and viewing photographs, for many years we have also been offering the special services of the Leica Akademie, with practical seminars and training courses, which are intended to share our knowledge about the world of photography, projection and magnification with both beginners and advanced photographic enthusiasts.

The contents of the courses, which are run by a trained team of experts in the modern, well-equipped training suite at our Solms factory and in the nearby Gut Altenberg, vary from general photography to areas of special interest and offer a range of suggestions, information and advice for your own work.

More detailed information and the current Leica Academy brochure are available from:

Leica Camera AG
Leica Akademie
Oskar-Barnack-Str. 11
D-35606 Solms
Phone: +49 (0) 64 42-208-421
Fax: +49 (0) 64 42-208-425
la@leica-camera.com

Leica on the Internet

Current information about products, news, events and the Leica company is available on our homepage on the Internet at:

<http://www.leica-camera.us>
<http://www.leica-camera.co.uk>

Leica information service

The Leica information service can provide you with an answer to any technical questions relating to the Leica range either in writing, on the telephone or by e-mail.

Leica Camera AG
Informations Service
Postfach 1180
D-35599 Solms
Phone: +49 (0) 64 42-208-111
Fax: +49 (0) 64 42-208-339
info@leica-camera.com

Leica Customer Service

Leica AG's Customer Service center, or the repair service of the Leica national offices (see the Warranty Card for an address list), is available to assist you in maintaining your Leica equipment or in case of damage. Please contact your nearest authorised Leica dealer.

Leica Camera AG
Customer Service
Solms Gewerbepark 8
D-35606 Solms
Phone: +49 (0) 64 42-208-189
Fax: +49 (0) 64 42-208-339
customer.service@leica-camera.com



my point of view

Leica Camera AG / Oskar-Barnack-Str. 11 / D-35606 Solms
www.leica-camera.com / info@leica-camera.com
Telefon +49 (0) 64 42-208-0 / Telefax +49 (0) 64 42-208-333