



LEICA M10-R
Instruction manual

FOREWORD

Dear Customer,

We wish you a great deal of fun and success taking photographs with your new Leica M10-R. Please read this manual thoroughly to familiarize yourself with the full scope of functions your camera has to offer. You can find all information about the Leica M10-R whenever you need it at M10-R.leica-camera.com.

Your Leica Camera AG

SCOPE OF DELIVERY

Before using your camera for the first time, please check that the accessories supplied are complete.

- Leica M10-R
- Camera bayonet cover
- Lithium-ion battery Leica BP-SCL5
- Battery charger Leica BC-SCL 5, incl. mains cable and in-car charger cable
- Carry strap
- Drawstring pouch for battery, charger and cables
- Quick Start Guide
- Test certificate
- Registration card

Subject to changes in design and production.

REPLACEMENT PARTS/ACCESSORIES

Please contact Leica Customer Care or visit the Leica Camera AG website for information on the extensive range of Leica replacement parts/accessories:

us.leica-camera.com/Photography/Leica-M/Technical-Equipment

Only the accessories specified and described in this manual or by Leica Camera AG must be used with the camera (battery, charger, mains plug, mains cable, etc.). These accessories should only be used with this product. Third-party accessories may result in malfunctions or damage to the product.

Please read the chapters “Legal information”, “Safety remarks”, and “General information” before using your camera for the first time. Knowledge of the content will prevent inadvertent damage to the product, possible injuries and other risks.

LEGAL INFORMATION

LEGAL INFORMATION

- Compliance with copyright laws is mandatory. The recording and publication of pre-recorded media like tapes, CDs or other published or broadcast material may breach copyright laws. The same applies for all software supplied in the scope of delivery.

IMPORTANT NOTES REGARDING THE USE OF GPS

Legal restrictions on use

- The use of GPS and associated technologies may be restricted in some countries or regions.
- You should therefore contact your travel agent or the embassy of your destination country for relevant information beforehand.
- The People's Republic of China and Cuba (exceptions: Hong Kong and Macao) prohibit the use of GPS within their territories and in the vicinity of their borders.

Violations will be prosecuted by local authorities.

Notes on function

- Prerequisite for GPS triangulation is “Line of Sight” (LoS) to at least 3 GPS satellites (up to 9 of the total 24 GPS satellites are available from any point on Earth at all times). The camera should therefore always be held with the GPS antenna pointing straight upwards.
- Make sure not to cover the GPS antenna with your hand or any object (specifically metallic objects).

- Perfect signal reception from GPS satellites may be impossible in the following locations or under the circumstances listed below. Geolocation may then be impossible or erratic at best.
 - in enclosed spaces
 - underground
 - under trees
 - in a moving vehicle
 - in the vicinity of tall buildings or in narrow valleys
 - in the vicinity of high-voltage lines
 - in tunnels
 - in the vicinity of mobile phones
 - with an accessory attached to the flash shoe, e.g. a flash unit

We recommend recommissioning the GPS function in a location with good signal reception if the camera has not been used for an extended period of time.

Notes on safe use

The electromagnetic radiation generated by the GPS system may affect electronic instruments and measuring devices. Make sure to disable the GPS function on board an aircraft before takeoff or landing, in hospitals and other locations where RF restrictions apply.

REGULATORY INFORMATION

You will find the manufacturing date of your camera on the stickers in the Warranty Card and/or on the packaging. The date format is year/month/day.

Specific regional approvals for this device can be found in the camera menu.

- ▶ Select **Camera Information** in the main menu
- ▶ Select **Regulatory Information**

CE mark

The CE mark on our products documents compliance with the fundamental requirements of applicable EU guidelines.

English

Declaration of Conformity (DoC)

Hereby, "Leica Camera AG" declares that this product is in compliance with the essential requirements and other relevant provisions of Directive 2014/53/EU.

Customers can download a copy of the original DoC to our Radio Equipment products from our DoC server: www.cert.leica-camera.com

In case of further questions, please contact: Leica Camera AG, Am Leitz-Park 5, 35578 Wetzlar, Germany

Depending on product (see technical data)

Type	Frequency band (central frequency)	Maximum power (dBm E.I.R.P.)
WLAN	2412-2462/5180-5240 MHz/ 5260-5320/5500-5700 MHz	20
Bluetooth® Wireless Technology	2402-2480 MHz	20

DISPOSAL OF ELECTRICAL AND ELECTRONIC EQUIPMENT



(Applies within the EU and for other European countries with active waste separation policies.)

This device contains electric and/or electronic components which must not be disposed of in general household waste. Instead, it should be disposed of at a recycling collection point provided by your local authority.

This service is free of charge. Any standard or rechargeable batteries used in this device must be removed and disposed of separately in accordance with local regulations.

Please contact your local authorities, waste disposal collection point or the retailer, from whom you purchased the device for more information on correct waste disposal.

IMPORTANT NOTES REGARDING THE USE OF WLAN/BLUETOOTH®

- Appropriate measures must be taken to ensure security and protect against disruptions to the systems in place where devices or computer systems are in use that require more stringent security than WLAN devices.
- Leica Camera AG shall not accept liability for damages arising from the use of the camera for purposes other than as a WLAN device.
- It is assumed that the WLAN function will be used in countries where this camera is sold. There may be a risk of breaching statutory wireless communication regulations when using the camera in other countries. Leica Camera AG shall not accept liability for such breaches.
- Please note that there is a risk of unauthorized third party interception of wirelessly communicated data. We highly recommend that you activate encryption in the wireless access point settings to ensure data safety.
- Avoid using the camera in areas where it can be exposed to magnetic fields, static electricity or other interferences, e.g. near a microwave oven. RF transmissions may otherwise not reach the camera.
- Using the camera near devices like microwave ovens or wireless phones that use the 2.4 GHz RF band may negatively affect the performance of both devices.
- Do not attempt to connect to wireless networks you are not authorized to use.
- The device will automatically search for wireless networks, once the WLAN function is enabled. A list, including networks you are not authorized to access, will be displayed (SSID: Network identifier for a WLAN network). Do not attempt to connect to

such a network, as this could be construed as unauthorized access.

- We recommend disabling the WLAN function while on an aircraft.
- Please read the important notes on specific functions of Leica FOTOS on p. 120.

SAFETY REMARKS

GENERAL INFORMATION

- Do not use your camera in the immediate vicinity of devices that generate powerful magnetic, electrostatic or electromagnetic fields (e.g. induction ovens, microwave ovens, television sets or computer screens, video game consoles, cell phones, broadcasting equipment). Their electromagnetic fields can interfere with recordings.
- Strong magnetic fields, e.g. from speakers or large electric motors can damage the stored picture data or disrupt recording.
- Switch off the camera, remove the battery briefly, replace it and switch the camera back on in case of a camera malfunction due to the effects of electromagnetic fields.
- Do not use the camera in the immediate vicinity of radio transmitters or high-voltage power lines. Their electromagnetic fields may interfere with recordings.
- Always store small parts e.g. the accessory shoe cover as follows:
 - out of the reach of children
 - in a safe location, where they will not get lost or stolen
- State-of-the-art electronic components are sensitive to static discharge. Since people can easily pick up charges of several 10,000 volts by walking on synthetic carpets, a discharge can occur when you touch the camera, and especially it is placed on a conductive surface. A static discharge on the camera housing poses no risk for the electronics. Despite built-in safety circuits, you should avoid direct contact with external camera contacts like those in the flash shoe.
- Take care not to soil or scratch the sensor for lens detection in the bayonet. You must similarly prevent direct contact of the bayonet with grains of sand or similar particles, as these could cause irreparable damage. This component must only be cleaned with a dry cloth (in system cameras).
- Use a cotton or linen cloth instead of a microfiber cloth from an optician's (synthetic) when cleaning the contacts. Make sure to discharge any electrostatic charge by deliberately touching a heating or water pipe (conductive, grounded material). Dirt deposits and oxidation on the contacts can be avoided by storing your camera in a dry location with the lens cap and the flash shoe/viewfinder cap (in system cameras) attached.
- Only use accessories specified for this model to prevent faults, short circuits or electric shock.
- Do not attempt to remove parts of the housing (covers) yourself. Repairs must be done at authorized service centers only.
- Protect the camera against contact with insect sprays and other aggressive chemicals. Petroleum spirit, thinner and alcohol must not be used for cleaning. Some chemicals and liquids can damage the camera housing or the surface finish.
- Rubber and plastics are known to expel aggressive chemicals and should therefore not be kept in contact with the camera for extended periods of time.
- Prevent any sand or dust or water penetration into the camera, e.g. during snowfall or rain or on the beach. Be extra careful when changing the lens (in system cameras) and when inserting or removing the memory card and rechargeable battery. Sand and dust can damage the camera, the lens, the memory card and the battery. Moisture can cause malfunctions and irreparable damage to the camera and memory card.

LENS

- A camera lens can have the effect of a magnifying glass when exposed to direct frontal sunlight. The camera must therefore be protected against extended exposure to direct sunlight.
- Attaching the lens cap and keeping the camera in the shade or ideally in its camera case, will help prevent damage to the interior of the camera.

RECHARGEABLE BATTERY

- Improper use of the batteries or the use of unapproved battery types may result in an explosion!
- Do not expose the rechargeable battery to sunlight, heat, humidity or moisture for prolonged periods of time. Likewise, the batteries must not be placed in a microwave oven or a high-pressure container as this would pose a fire or explosion hazard.
- Do not under any circumstances charge or insert a damp or wet battery into the camera!
- A safety valve in the battery ensures that any excess pressure caused by improper handling is discharged safely. It is nevertheless important to dispose of a bloated battery immediately. It may pose an explosion hazard!
- Keep the battery contacts clean and easily accessible. Although lithium-ion batteries are secured against short circuits, they should still be protected against contact with metal objects like paper clips or jewelry. A short-circuited battery can get very hot and cause severe burns.

- When a battery is accidentally dropped, make sure to check the housing and the contacts immediately for any damage. A damaged battery can damage the camera.
- The battery must be removed from the camera or charger and must be replaced immediately in case of a strange smell, discoloration, deformation, overheating or leakage. Continued use of the battery may result in overheating, which can cause fire and/or explosion!
- Never throw batteries into a fire as they may explode.
- Keep the battery away from sources of heat in case of leakage or if you smell burning. Leaked fluid can catch fire!
- The use of other chargers not approved by Leica Camera AG can cause damage to the batteries – and in extreme cases – cause serious or life-threatening injuries.
- Make sure that the power socket is freely accessible at all times.
- Do not attempt to open the battery or the charger. Repairs must only be carried out by authorized service centers.
- Keep batteries out of the reach of children. Batteries can cause suffocation when swallowed.

FIRST AID

- Battery fluid may cause blindness if it comes into contact with the eyes. Rinse the eyes thoroughly with clean water immediately. Avoid rubbing. Seek medical attention immediately.
- Leaked battery fluid poses an injury hazard when it comes in contact with clothing or skin. Rinse the affected areas thoroughly with clean water.

CHARGER

- Using the charger in the vicinity of broadcasting receivers may interfere with reception. Ensure a distance of at least 1 m (3 ft) between the charger and the receiver.
- When the charger is in use, it may emit a buzzing sound – this is normal and not a malfunction.
- Disconnect the charger from the mains when it is not in use, as it consumes electricity (a very small amount), even if no battery is inserted.
- Always keep the charger contacts clean, and never short circuit them.
- The car charging cable supplied must only be operated in 12 V in-car grids and must never be connected while the charger is connected to mains electricity.

MEMORY CARD

- Never remove the memory card during a datasave or card reading process. The camera must not be switched off or be subjected to impact or vibrations while working.
- Do not open the cover/remove the memory card or the battery while the status LED is lit, which indicates memory access. Data on the card may otherwise be destroyed and camera malfunctions may occur.
- Do not drop or bend memory cards as this will cause damage and result in the loss of stored data.
- Do not touch the connections on the reverse of the memory card and keep them clean and dry.
- Keep memory cards out of the reach of children. Swallowing a memory card may cause suffocation.

SENSOR

- Cosmic radiation (e.g. during flights) may cause pixel defects.

CARRY STRAP

- Carry straps are usually made of very robust material. You should therefore keep it out of the reach of children. A carry strap is not a toy and poses a strangulation risk.
- Use the carry strap only for its intended purpose on a camera or on binoculars. Any other use poses the risk of injury and may possibly result in damage to the carry strap and is therefore not permitted.
- Carry straps should also not be used for cameras/binoculars during sports activities that pose a risk of entanglement (e.g. when mountain climbing and similar outdoor activities).

TRIPOD

- When using a tripod, make sure it is standing securely and turn the camera only by turning the tripod, not the actual camera. Ensure that the tripod screw is hand-tightened only. Avoid transporting the camera while the tripod is attached. You might injure yourself or others and the camera could get damaged.

FLASH

- The use of incompatible flash units with your Leica M10-R may result in irreparable damage to the camera and/or the flash unit.

GENERAL INFORMATION

Please read the section about “Care/Maintenance” for more information about what to do in case of problems.

CAMERA/LENS

(For system cameras)

- Make a note of the serial numbers of your camera (engraved in the base of the camera housing) and lenses, as this information will be extremely important in case of loss.
- Make sure to always have a lens or the camera bayonet cover attached to prevent dust or other foreign bodies penetrating the camera.
- That is why you should always replace lenses quickly and in a dust-free environment.
- Never store the camera bayonet cover or the lens back cover in a pants pocket, as they will attract lint and dust, which could then be accidentally introduced into the camera.

LCD PANEL

- Condensation may form on the LCD panel if the camera is exposed to great temperature fluctuations. Wipe the screen carefully with a soft, dry cloth.
- The screen image will initially be slightly darker than normal if the camera is very cold when it is switched on. The normal level of brightness will be reached as soon as the LCD panel warms up.

RECHARGEABLE BATTERY

- The battery must have a temperature between + 0°C and + 30°C for charging (otherwise the charger will not switch on or will switch off again immediately).
- Lithium-ion batteries can be charged at any time, regardless of their current charge level. A partially charged battery will charge to full capacity faster than a fully discharged one.
- The rechargeable batteries come only partly charged ex works and should therefore be charged fully before their first use.
- A new battery only reaches its full capacity after it has been fully charged and – by using it in the camera – depleted 2 to 3 times. This depletion process should be repeated roughly every 25 cycles.
- Battery and charger heat up during the charging process. That is normal and not a malfunction.
- Rapid flashing of the two LEDs (> 2 Hz) when charging commences indicates a charging error (e.g. maximum charging time exceeded, voltages or temperatures outside permitted ranges or a short circuit). Disconnect the charger from the mains and remove the battery. Ensure that the above temperature conditions are met and then restart the charging process. Please contact your dealer, the Leica representative in your region or Leica Camera AG if the problem persists.
- Rechargeable lithium-ion batteries generate power by way of internal chemical reactions. These reactions are influenced by ambient temperature and humidity. To ensure a maximum service life of the battery, it should not be exposed to extreme temperatures (high or low) for extended periods of time (e.g. in a parked car in the summer or winter).

- However, every battery has a limited service life! After several hundred charging cycles, this limitation will become evident as the operating times get significantly shorter.
- The replaceable battery supplies power to a backup battery, which is permanently installed in the camera. This backup battery retains the date and time for some weeks. Once the backup battery is depleted, it must be replenished by inserting a charged main battery. The time and date will have to be set again after a full depletion of both batteries.
- As the battery capacity deteriorates or if using an older battery, warning messages may appear and some functions may be restricted or blocked entirely.
- Always remove the battery if the camera will not be used for an extended period of time. Make sure to switch the camera off via the main switch before removing the battery. Leaving the battery in the camera will result in a deep discharge after a few weeks. Voltage levels will decrease significantly, as the camera uses a low idle current to maintain settings.
- Dispose of damaged batteries in accordance with the relevant regulations at an approved collection point for proper recycling.
- The date of manufacture can be found on the battery. The date format is week/year.

MEMORY CARD

- The range of available SD/SDHC/SDXC cards on the market is too extensive for Leica Camera AG to test for compatibility and quality. Generally, any type of memory card may be used without any damage to the camera or memory card. As some "no name" cards may not fully comply with the SD/SDHC/SDXC standards, Leica Camera AG cannot provide any guarantee of function.
- We recommend formatting memory cards from time to time, as fragmented residual data from deleted files may block some of the storage capacity.
- Generally, it is not necessary to format (initialize) memory cards that have been previously used. Formatting will, however, be necessary if you insert an unformatted memory card or a card that was formatted in another device (e.g. a computer) for the first time.
- We recommend backing up your data on a PC, because electromagnetic fields, static electricity and any damage to the memory card or camera defects may result in irretrievable damage or loss of your data.
- SD, SDHC, and SDXC memory cards come with a write protection slider to prevent accidental overwriting. This slider is located on the non-beveled side of the card. All data on the card is protected when the slider is set to its lower position, marked LOCK.
- All data stored on a memory card will be lost during formatting. Formatting will not be prevented by the deletion protection set for individual pictures.

SENSOR

- Any dust or dirt particles stuck to the glass cover of the sensor may result in noticeable dark stains or specks on the pictures (in system cameras). You can send your camera to the Leica Customer Care department for sensor cleaning (see p. 146). This service is not part of the warranty offering and will therefore incur charges.

DATA

- All data, including personal information, may be changed or deleted due to incorrect or accidental operation, static discharge, accidents, malfunctions, repairs and other measures.
- Please note that Leica Camera AG does NOT accept liability for direct or consequential damage due to the manipulation or destruction of data and personal information.

FIRMWARE UPDATE

Leica is continuously working on the further development and optimization of Leica M10-R. As digital cameras have many functions that are controlled electronically, improvements and enhancements to the functions can be installed on the camera retroactively. Leica releases what are known as firmware updates at irregular intervals. Cameras are always supplied ex works with the latest firmware installed or you can download the latest version from our website yourself and transfer it to your camera.

You will receive a newsletter informing you of the availability of a new firmware update if you register your camera on the Leica Camera homepage.

Visit the download section or the "Customer Area" for information about how to register or how to get firmware updates for your Leica M10-R. Additionally, you can find information about changes or additions to the manual at: club.leica-camera.com

Leica releases firmware updates for lenses at irregular intervals. You can download any new firmware version from our homepage and transfer it to your lens. Please see p. 119 for more information.

Select the menu item **Camera Information** (see p. 119) to check whether your camera and lenses are running the latest firmware version.

WARRANTY

In addition to your statutory warranty rights regarding your dealer, you will receive an additional Leica Camera AG product warranty valid from the date of purchase at an authorized Leica retailer. Previously, the product warranty was included with the product in the packaging. From now on, the product warranty will only be available online as a new service. You will be able to review the warranty conditions for your product at any time, without having to search for the document. Please note that this new policy applies only for products that are no longer delivered with a hardcopy product warranty included in the packaging. Any products still delivered with the warranty document in the packaging remain governed exclusively by that document. For more information regarding the warranty scope, services and limitations, please visit: warranty.leica-camera.com

TABLE OF CONTENT

FOREWORD	2
SCOPE OF DELIVERY	2
REPLACEMENT PARTS/ACCESSORIES	3
LEGAL INFORMATION	4
SAFETY REMARKS	8
GENERAL INFORMATION	12
WARRANTY	15
TABLE OF CONTENT	16
PART DESIGNATIONS	20
DISPLAYS	24
VIEWFINDER	24
LCD PANEL	25
WHEN TAKING A PICTURE.....	25
IN REVIEW MODE.....	25
PREPARATION	28
ATTACHING THE CARRY STRAP	28
PREPARING THE CHARGER	28
CHARGING THE BATTERY.....	29
INSERTING/REMOVING THE BATTERY	30
INSERTING/REMOVING THE MEMORY CARD	31
LENS	33
COMPATIBLE LENSES	33
LENSES WITH LIMITED COMPATIBILITY	34
INCOMPATIBLE LENSES	34
CHANGING THE LENS.....	35
LENS DETECTION.....	38
USING A LEICA M LENS <u>WITH</u> 6-BIT ENCODING.....	38
USING A LEICA M LENS <u>WITHOUT</u> 6-BIT ENCODING	38

USING A LEICA R LENS.....	39
DISABLING LENS DETECTION	39
DIOPTER ADJUSTMENT	40
CAMERA OPERATION.....	42
CONTROL ELEMENTS.....	42
MAIN SWITCH	42
SHUTTER BUTTON	43
SHUTTER SPEED SETTING DIAL	44
ISO SETTING WHEEL.....	44
THUMBWHEEL	45
FOCUS BUTTON	45
DIRECTIONAL PAD/CENTER BUTTON.....	45
LV BUTTON/PLAY BUTTON/MENU BUTTON	46
LCD PANEL	46
MENU CONTROL.....	48
CONTROL ELEMENTS	48
MENU SECTIONS	48
FAVORITES MENU.....	48
MAIN MENU	49
SUBMENU	49
MENU NAVIGATION	50
SUBMENU	51
KEYBOARD/NUMBER PAD	51
SCALE MENU.....	52
DATE/TIME MENU	53
COMBI MENU	53
QUICK ACCESS	54
FAVORITES MENU	54
MANAGING THE FAVORITES MENU	54
VIA THE STATUS SCREEN	55
DIRECT ACCESS	55
CAMERA BASIC SETTINGS	56
MENU LANGUAGE	56
DATE/TIME.....	56

DATE	56	SPLIT IMAGE METHOD	68
TIME.....	56	IN LIVE VIEW MODE.....	69
AUTOMATIC TIME VIA GPS	56	FOCUS PEAKING.....	69
TIME ZONE	57	ENLARGEMENT.....	70
DAYLIGHT SAVING TIME	57	ACCESSING ASSIST FUNCTIONS	70
POWER SAVE MODE (STANDBY MODE).....	57	ISO SENSITIVITY.....	72
STATUS LED	58	FIXED ISO VALUES.....	72
DISPLAY/VIEWFINDER SETTINGS	58	AUTOMATIC SETTING.....	73
BRIGHTNESS.....	59	LIMITING SETTING RANGES	73
RANGEFINDER.....	59	WHITE BALANCE	74
LCD PANEL	59	AUTOMATIC CONTROL/FIXED SETTINGS.....	74
LEICA VISOFLEX (EVF)	59	MANUAL SETTING VIA METERING	75
BRIGHTNESS.....	59	DIRECT SETTING OF THE COLOR TEMPERATURE.....	76
LCD PANEL/EVF USE.....	60	EXPOSURE.....	76
MENU CONTROL FOR PLAYBACK/REVIEW MODE.....	60	EXPOSURE METERING METHODS.....	76
LIVE VIEW MODE (RECORDING MODE).....	60	SPOT METERING.....	76
AUTO REVIEW	60	CENTER-WEIGHTED METERING.....	76
BASIC PICTURE SETTINGS	62	MULTI-FIELD METERING.....	76
FILE FORMAT	62	EXPOSURE MODES	77
JPG SETTINGS	62	APERTURE PRIORITY - A.....	78
RESOLUTION	62	MANUAL EXPOSURE SETTING - M.....	79
IMAGE PROPERTIES.....	63	LONG-TERM EXPOSURE (B).....	80
COLOR SATURATION.....	63	EXPOSURE CONTROL	81
MONOCHROME PHOTOGRAPHY	63	EXPOSURE PREVIEW.....	81
PICTURE MODE.....	64	METERING MEMORY LOCK	82
DRIVE MODE.....	64	EXPOSURE COMPENSATION.....	83
IMAGE TYPES.....	65	PICTURE RECORDING MODES.....	84
USING THE RANGEFINDER.....	65	SERIAL EXPOSURES	84
IMAGE FIELD (BRIGHT-LINE FRAME).....	65	INTERVAL SHOOTING	85
LIVE VIEW MODE	67	SPECIFYING THE NUMBER OF FRAMES.....	85
FOCUSING.....	68	SPECIFYING THE INTERVALS BETWEEN SHOTS.....	85
VIA RANGEFINDER.....	68	EXPOSURE BRACKETING.....	86
SUPERIMPOSED IMAGE METHOD (DOUBLE IMAGE).....	68	SELF-TIMER.....	87
		INFO DISPLAYS.....	88
		INFO DISPLAYS IN PICTURE MODE.....	88

AUXILIARY DISPLAYS.....	89	CREATING A NEW FOLDER	115
CLIPPING.....	89	RESETTING IMAGE NUMBERING	115
LEVEL GAUGE	90	ADDING COPYRIGHT INFORMATION.....	116
GRID.....	91	RECORDING THE IMAGE LOCATION WITH GPS	116
HISTOGRAM	91	FORMATTING A MEMORY CARD.....	117
FLASH PHOTOGRAPHY	92	DATA TRANSFER	118
COMPATIBLE FLASH UNITS.....	92	USING RAW DATA (DNG).....	118
FLASH EXPOSURE METERING (TTL METERING).....	93	RESETTING THE CAMERA TO FACTORY SETTINGS.....	118
HSS (HIGH SPEED SYNC.).....	94	FIRMWARE UPDATES	119
FLASH CONTROL	95	UPDATING THE CAMERA FIRMWARE	119
SYNC POINT	95	LEICA FOTOS	120
FLASH RANGE.....	96	CONNECTION.....	120
FLASH EXPOSURE COMPENSATION	96	SHUTTING DOWN THE CONNECTION.....	121
FLASH EXPOSURE DISPLAYS IN THE VIEWFINDER.....	98	REMOTE CAMERA CONTROL	121
REVIEW MODE	100	CARE/STORAGE	122
CONTROL ELEMENTS IN REVIEW MODE.....	100	SENSOR.....	124
INITIATE/EXIT REVIEW MODE.....	101	DUST DETECTION	124
SELECTING/SCROLLING THROUGH RECORDINGS.....	101	SENSOR CLEANING	124
INFO DISPLAYS IN REVIEW MODE.....	102	FAQ.....	126
CROPPED SECTION ZOOM.....	103	MENU OVERVIEW	132
DISPLAYING MULTIPLE RECORDINGS AT ONCE.....	104	INDEX.....	136
TAGGING/RATING OF RECORDINGS.....	106	TECHNICAL DATA.....	142
DELETING RECORDINGS.....	107	LEICA CUSTOMER CARE.....	146
DELETING INDIVIDUAL RECORDINGS.....	108	LEICA AKADEMIE.....	146
DELETING ALL RECORDINGS	109		
DELETING UNRATED RECORDINGS	110		
PREVIEW OF LATEST RECORDING	111		
OTHER FUNCTIONS	112		
USER PROFILES	112		
DATA MANAGEMENT	114		
DATA STRUCTURE ON THE MEMORY CARD.....	114		
EDIT FILE NAMES.....	115		

Definition of the various categories of information found in this manual**Note**

Additional information

Important

Failure to observe the instructions may result in damage to the camera, the accessories or the pictures

Attention

Non-compliance may result in personal injury

PART DESIGNATIONS

LEICA M 10-R

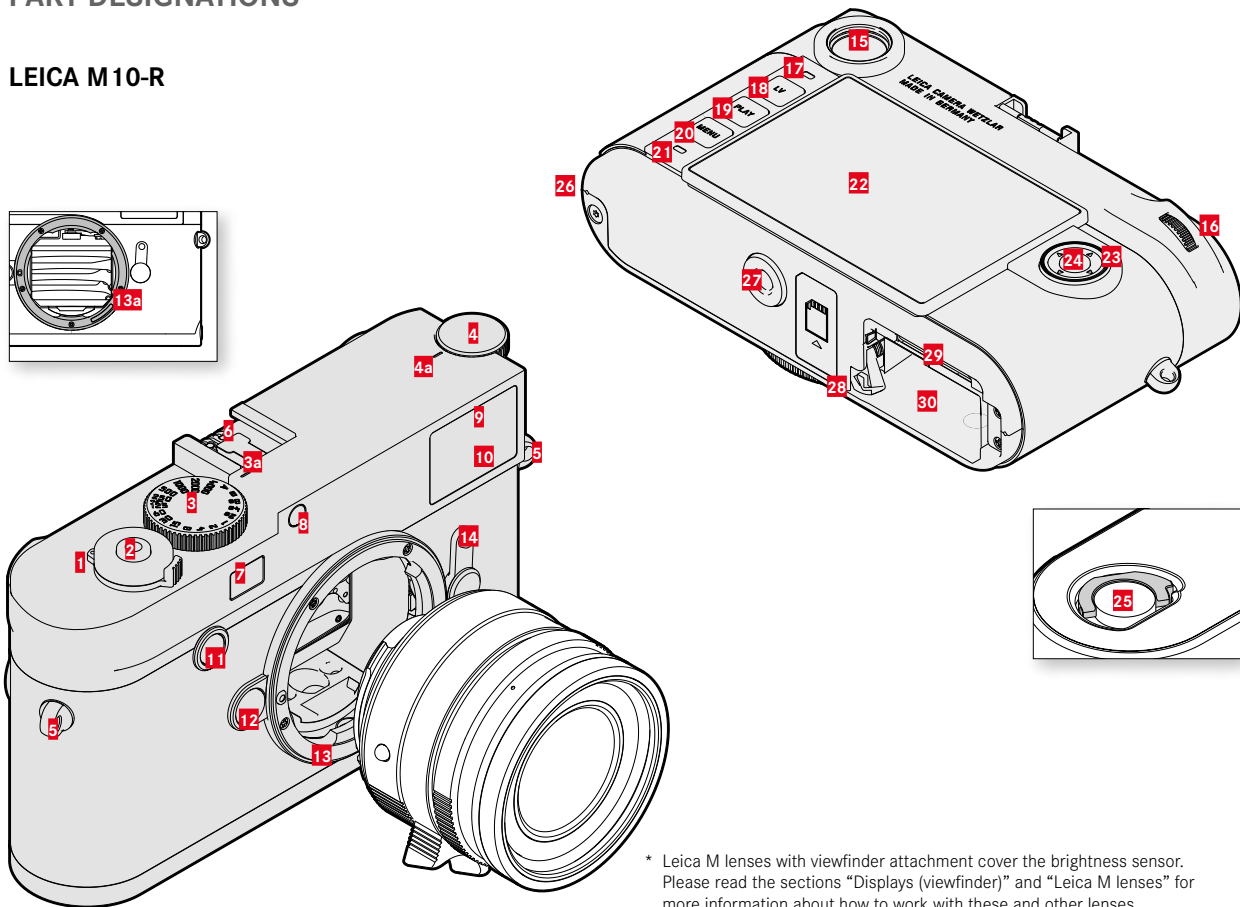

* Leica M lenses with viewfinder attachment cover the brightness sensor. Please read the sections "Displays (viewfinder)" and "Leica M lenses" for more information about how to work with these and other lenses.

- 1 Main switch
- 2 Shutter button
- 3 Shutter speed setting dial
- a Alignment point for shutter speed setting dial
- 4 ISO setting wheel
- a Index for ISO setting wheel
- 5 Strap lugs
- 6 Accessory shoe
- 7 Rangefinder window
- 8 Brightness sensor*
- 9 Self-timer LED
- 10 Viewfinder window
- 11 Focus button
- 12 Lens release button
- 13 Leica M bayonet
 - a 6-bit encoding
(sensor for lens detection)
- 14 Image field selector
- 15 Viewfinder eyepiece
- 16 Thumbwheel
- 17 Brightness sensor for LCD panel
- 18 **LV** button
- 19 **PLAY** button
- 20 **MENU** button
- 21 Status LED
- 22 LCD panel
- 23 Directional pad
- 24 Center button
- 25 Locking toggle for bottom cover
- 26 Bottom cover locking point
- 27 Tripod thread A ¼, DIN 4503 (¼")
- 28 Battery release lever
- 29 Memory card slot
- 30 Battery compartment

LENS*

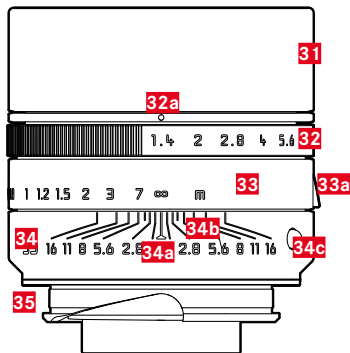

- 31** Lens hood
- 32** Aperture setting ring with scale
 - a** Index for exposure values
- 33** Focus ring
 - a** Focus tab
- 34** Fixed ring
 - a** Alignment point for focus setting
 - b** Depth of field scale
 - c** Alignment button for lens replacement
- 35** 6-bit encoding

* Not included in the delivery package. Representative image. Technical features may vary depending on model.

DISPLAYS

VIEWFINDER

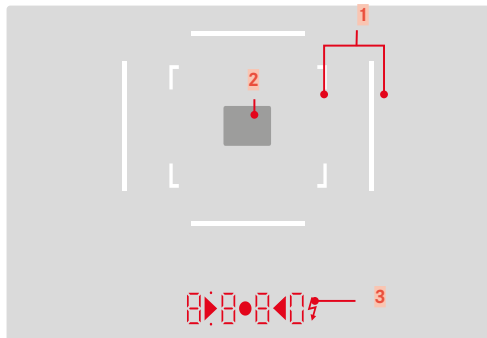

- 1** Bright-line frame (e.g. 50 mm + 75 mm)
- 2** Metering field for focusing

- 3** Digital display
 - a. **8 8 8 0**:
 - Displays the automatically calculated shutter speed in aperture priority mode **A** or the countdown of longer shutter speeds in 1 s increments.
 - Warning that the metering or setting ranges are overshot or undershot using aperture priority mode **A**
 - Exposure compensation value (appears for a short time during setting and for about 0.5 s when activating exposure metering by tapping the shutter button)
 - Notification for (temporarily) full cache
 - Message: No memory card (**Sd**)
 - Message: Memory card full (**Full**)
 - b. **•** (top):
 - Indicates (when lit) that the metering memory lock is active
 - c. **•** (bottom):
 - Indicates (flashing) that exposure compensation is in use
 - d. **▶ • ◀**:
 - For manual exposure setting:
Concurrently as light balance for exposure compensation. The triangular LEDs give the direction of rotation of the aperture setting ring and shutter speed setting dial to adjust the exposure.
 - Warning before the measuring range is undercut
 - e. **⚡** Flash symbol:
 - Flash ready to use
 - Details of flash exposure before and after exposure

LCD PANEL

WHEN TAKING A PICTURE

All displays/values refer to the actual settings

In Live View mode

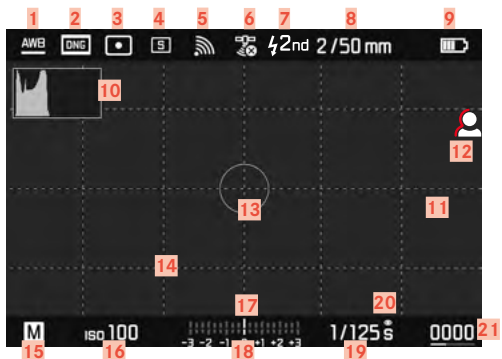

IN REVIEW MODE

All displays/values refer to the actual settings



When using the rangefinder

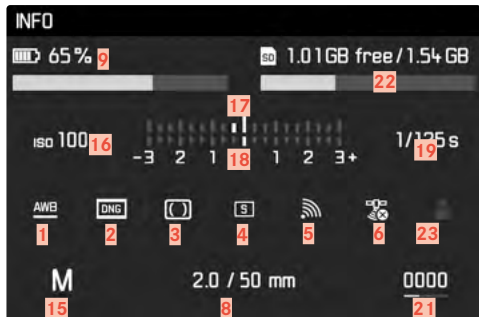







- 1 White balance mode
(not available in monochrome models)
- 2 File format/compression level/resolution
- 3 Exposure metering method
- 4 Picture mode (Drive Mode)
- 5 WLAN/Leica FOTOS
- 6 GPS
- 7 Flash sync point
- 8 Lens information
- 9 Battery capacity
- 10 Histogram
- 11 Clipping identification of underexposed (blue), or overexposed subject sections (red)
- 12 Focus peaking
(identification of in sharp edges in the object)
- 13 Exposure metering field
(only available in Spot exposure metering method)
- 14 Grid lines (choice of 2 variants)
- 15 Exposure mode
- 16 ISO Sensitivity
- 17 Light balance
- 18 Exposure compensation scale
- 19 Shutter speed
- 20 Exposure preview
- 21 Remaining number of exposures incl. trend detection via bar chart
- 22 Remaining memory card capacity
- 23 User profile
- 24 File name
- 25 Icon for marked picture
- 26 Display of cropped section size and position
(only visible for enlarged sections)
- 27 File number of the picture shown

CHARGE STATUS INDICATOR ON THE LCD PANEL

The battery charge status is displayed in the status pane and in the header line.



Display	Charge status
	approx. 80 - 100%
	approx. 65 - 80%
	approx. 45 - 65%
	approx. 25 - 45%
	approx. 10 - 25%
	approx. 0 - 10% The battery needs charging or replacing

PREPARATION

ATTACHING THE CARRY STRAP

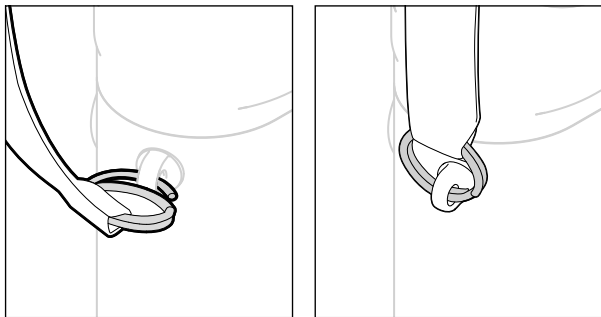

Attention

- Once you have attached the carry strap, please make sure that the clips are mounted correctly to prevent the camera from falling.

PREPARING THE CHARGER

Use the mains cable with the matching regional plug to connect the charger to mains electricity.

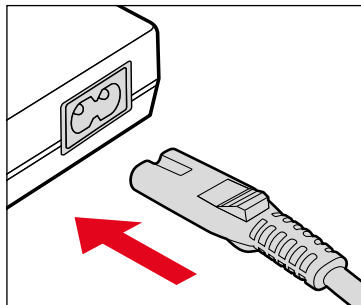

Note

- The charger will automatically adapt to local mains voltage.

CHARGING THE BATTERY

The camera is powered by a lithium-ion battery.

INSERTING THE BATTERY IN THE CHARGER

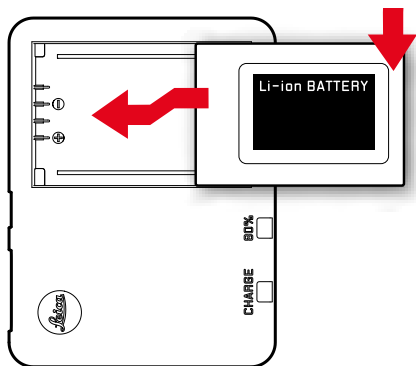

- ▶ Slide the battery into the charger with the grooves facing down, until the contacts meet
- ▶ Press down on the battery until you can hear and feel it clicking into place
- ▶ Ensure that the battery is fully inserted into the charger

REMOVING THE BATTERY FROM THE CHARGER

- ▶ Tilt the battery up and lift it out at an angle

CHARGE STATUS INDICATORS ON THE CHARGER

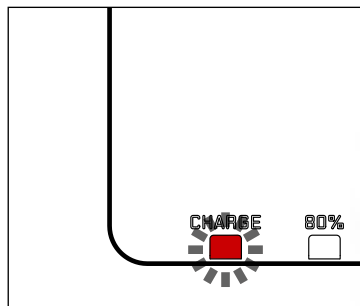

The status LED indicates a correct charging process.

Display	Charge status	Charge time*
CHARGE flashes green	battery is charging	
80% lights up orange	80%	approx. 2 hours
CHARGE continuous green light	100%	approx. 3½ h

Disconnect the charger from mains electricity when the charging process is complete. There is no risk of overcharging.

* for a completely discharged battery

INSERTING/REMOVING THE BATTERY

- ▶ Ensure that the camera is switched OFF (see p. 42)
- ▶ Open the bottom cover and close it again afterwards (see p. 32)

Important

- Removing the battery while the camera is switched on may result in the loss of custom settings or damage to the memory card.
- Make sure that the bottom cover is securely closed before switching on the camera.

INSERTION

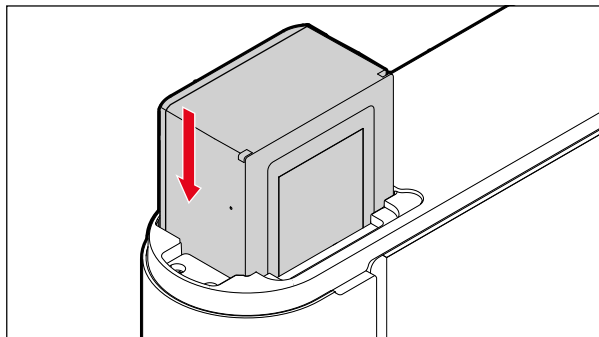

REMOVAL

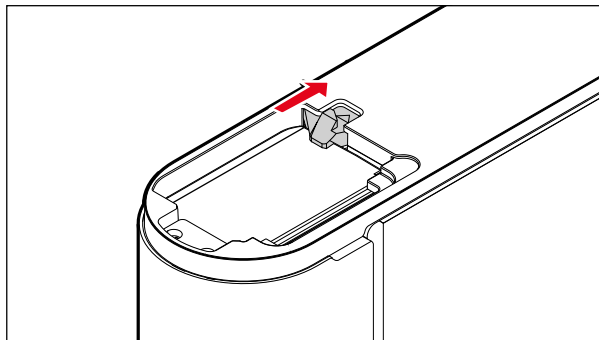

INSERTING/REMOVING THE MEMORY CARD

The camera will save exposures to an SD (Secure Digital), SDHC (High Capacity) or SDXC (eXtended Capacity) memory card.

Notes

- SD/SDHC/SDXC memory cards are available from various suppliers in various sizes and with differing read/write speeds. Memory cards with high storage capacities and high read/write speeds offer quick storage and rendering.
- The memory card may not be supported (capacity) or will have to be formatted before first use (see p. 117). The camera will in that case display a relevant message. Please see the section "Technical Data" for information about supported cards.
- Check the memory card for correct alignment if you are having difficulties inserting it into the camera.
- See p. 10 and p. 13 for additional information.
- Removing the bottom cover or the memory card while the camera is switched on, or switching on the camera while the bottom cover is not attached will trigger the following warning message on the display:
 - Bottom cover removed
 - No card available

The memory card slot is located directly next to the battery compartment.

- ▶ Ensure that the camera is switched OFF (see p. 42)
- ▶ Open the bottom cover and close it again afterwards (see p. 32)

INSERTION

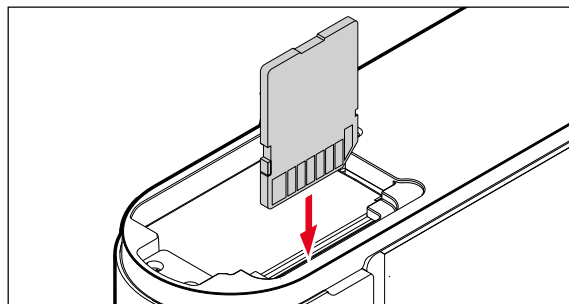

REMOVAL

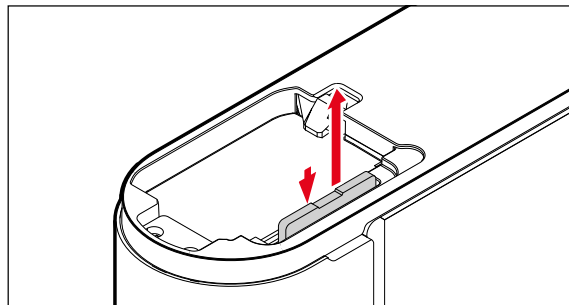

OPEN/CLOSE THE BOTTOM COVER

OPEN

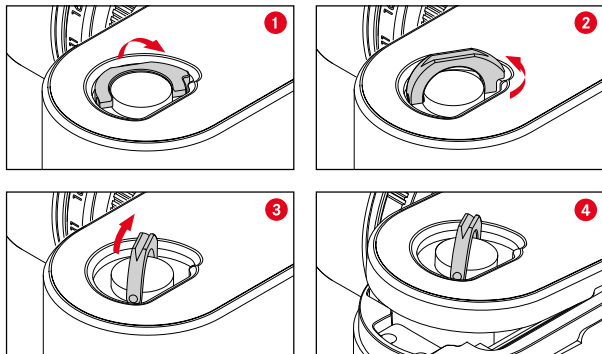

- ▶ Click up the locking toggle
- ▶ Turn the locking toggle in anti-clockwise direction
- ▶ Remove the bottom cover

CLOSE

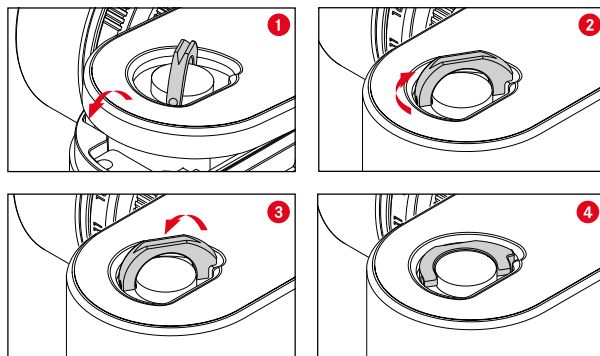

- ▶ Insert the bottom cover
- ▶ Turn the locking toggle in clockwise direction
- ▶ Click down the locking toggle
- ▶ Check that the bottom cover was inserted and closed correctly

LENS

COMPATIBLE LENSES

LEICA M LENSES

Most Leica M lenses can be used with any lens equipment (with or without 6-bit encoding in the bayonet). Your camera will also deliver great pictures with Leica M lenses without encoding. We recommend entering the lens model type manually to ensure the best possible image quality (see p. 38).

Please read the following sections for details on the very few exceptions and limitations.

Notes

- Our Leica Customer Care department can retrofit many Leica M lenses with 6-bit encoding.
- Leica M lenses come with a control curve that mechanically transfers the set distance to the camera to allow manual focusing via the rangefinder of the Leica M camera. Please note the following when using the rangefinder with wide-aperture lenses (≥ 1.4):
 - The focusing mechanism of every camera and every lens is adjusted individually at the Leica Camera AG factory in Wetzlar with the greatest possible precision. Extremely narrow tolerances are adhered to in this process, which allow precise focusing of every camera/lens combination in photographic practice.

- If wide-aperture lenses (≥ 1.4) are used with an open aperture, the then sometimes resulting very low depth of field and inaccuracies in focusing with the rangefinder may lead to setting errors resulting from the (added) overall tolerance of the camera and lens. It can therefore not be ruled out that a specific camera/lens combination may result in systematic deviations.
- We recommend having the lens and camera checked by Leica Customer Care if you notice a general deviation of the focal position in a specific direction over time. Our technicians will ensure that both products are calibrated within the permissible overall tolerance. However, a 100% match of the focal position cannot be achieved for all pairings of cameras and lenses.

LEICA R-LENSES (WITH ADAPTER)

The optional accessory Leica R-Adapter M allows the use of Leica-R lenses as well as Leica M lenses. Please visit the Leica Camera AG website for more information on this accessory. [us.leica-camera.com/Photography/Leica-M/Technical-Equipment](https://www.us.leica-camera.com/Photography/Leica-M/Technical-Equipment)

LENSES WITH LIMITED COMPATIBILITY

COMPATIBLE, BUT MAY POSE RISK OF DAMAGE TO THE CAMERA AND/OR LENS

- Lenses with retractable tube must only be used with the tube extended, i.e. never attempt to retract the tube while the lens is attached to the camera. This does not apply for the current Makro-Elmar-M 90 f/4 model, as its tube will not retract into the camera itself and can therefore be used without restriction.
- When using Heavy lenses attached to a tripod-mounted camera, e.g. Noctilux 50 f/0.95 or Leica R lenses with an adapter: make sure that the tilt of the tripod head cannot move inadvertently when the camera is not held. A sudden tilt and impact could result in damage to the lower edge of the camera bayonet. That is why you should always use the tripod mount on relevantly equipped lenses.

COMPATIBLE, BUT EXACT FOCUSING MAY BE LIMITED

Despite the high precision of the rangefinder on the camera, exact focusing with 135 mm lenses with an open aperture cannot be guaranteed due to the very low depth of field. We therefore recommend stopping down by at least 2 steps. Live View mode, on the other hand, plus the various setting aids provided, allow unrestricted use of this lens.

USABLE, BUT EXPOSURE METERING IS POSSIBLE ONLY IN LIVE VIEW MODE

- Super-Angulon-M 21 f/4
- Super-Angulon-M 21 f/3.4
- Elmarit-M 28 f/2.8 (Serial numbers below 2 314 921)

INCOMPATIBLE LENSES

- Hologon 15 f/8
- Summicron 50 f/2 with close-up function
- Elmar 90 f/4 with retractable tube (manufactured 1954-1968)
- Some examples of the Summilux-M 35 f/1.4 (non-aspherical, manufactured 1961-1995, Made in Canada) cannot be attached to the camera or cannot focus to infinity. Leica Customer Care can modify these lenses for use with the camera.

CHANGING THE LENS

LEICA M LENSES

ATTACHING

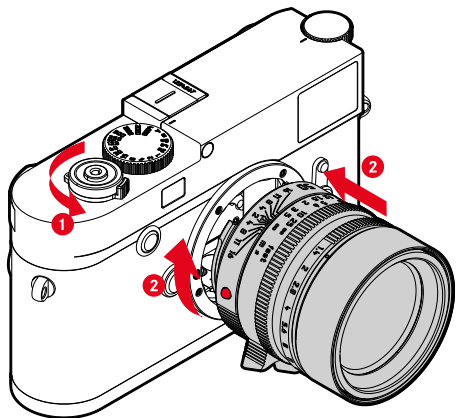

- ▶ Ensure that the camera is switched OFF (see p. 42)
- ▶ Hold the lens on the fixed ring
- ▶ Position the alignment button on the lens opposite the release button on the camera housing
- ▶ Attach the lens in this position
- ▶ Turn the lens clockwise until you hear and feel it click into place

DETACHING

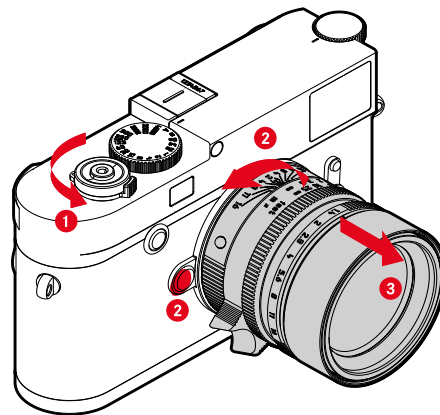

- ▶ Ensure that the camera is switched OFF
- ▶ Hold the lens on the fixed ring
- ▶ Press and hold the release button on the camera housing
- ▶ Turn the lens counter-clockwise until the alignment button is opposite the release button
- ▶ Remove the lens

Important

- Make sure to always have a lens or the camera bayonet cover attached to prevent dust or other foreign bodies penetrating the camera.
- That is why you should always replace lenses quickly and in a dust-free environment.

OTHER LENSES

(e.g. Leica R lenses)

Other lenses can be used by inserting an adapter for M bayonets (e.g. Leica R-Adapter M).

ATTACHING THE ADAPTER

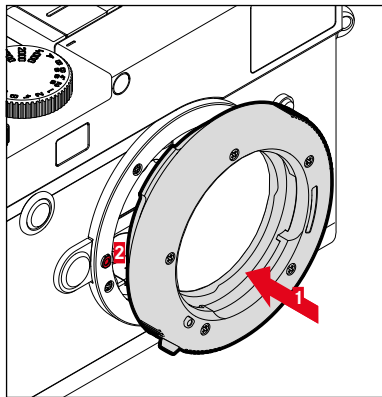

- ▶ Ensure that the camera is switched OFF (see p. 42)
- ▶ Position the alignment point on the adapter opposite the alignment point on the camera housing
- ▶ Attach the lens in this position
- ▶ Turn the adapter clockwise until you hear and feel it click into place
- ▶ Attach the lens immediately

DETACHING THE ADAPTER

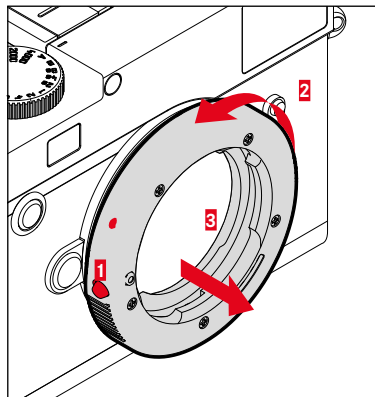

- ▶ Ensure that the camera is switched OFF
- ▶ Detaching the lens
- ▶ Press and hold the release button on the camera housing
- ▶ Turn the adapter counter-clockwise until the alignment point is opposite the release button
- ▶ Remove the adapter

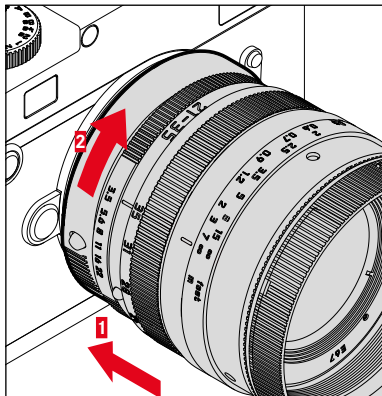
ATTACHING THE LENS TO THE ADAPTER

- ▶ Ensure that the camera is switched OFF
- ▶ Hold the lens on the fixed ring
- ▶ Position the alignment point on the lens opposite the alignment point on the adapter
- ▶ Attach the lens in this position
- ▶ Turn the lens clockwise until you hear and feel it click into place

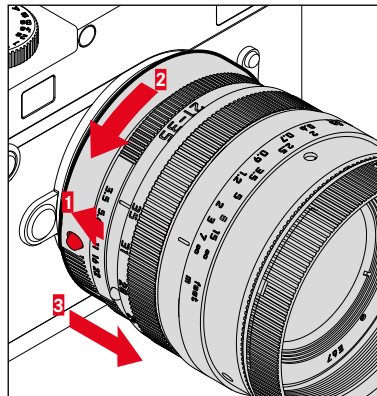
DETACHING THE LENS FROM THE ADAPTER

- ▶ Ensure that the camera is switched OFF
- ▶ Hold the lens on the fixed ring
- ▶ Press and hold the release button on the adapter
- ▶ Turn the lens counter-clockwise until its alignment point is opposite the release button
- ▶ Remove the lens

LENS DETECTION

The 6-bit encoding in the bayonet of current model Leica M lenses allows the camera to detect the lens type.

- This information is used for e.g. picture data optimization. Edge darkening, for example, which can become noticeable when wide-angle lenses and large apertures are used, is compensated in the relevant picture data.
- The information provided by the 6-bit encoding is also written to the Exif data of the pictures. The focal length of the lens is additionally displayed when rendering the extended picture data.
- The camera will write an approximate exposure value to the Exif picture data, which is calculated individually using the exposure metering system. This is done whether or not an encoded or unencoded lens or a non-M lens is attached via adapter, and regardless of whether the lens type was entered in the menu.

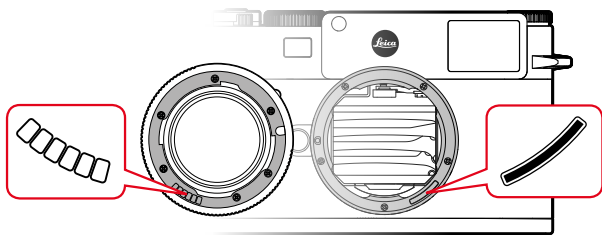

USING A LEICA M LENS WITH 6-BIT ENCODING

The camera will automatically set the correct lens type when a Leica M lens with 6-bit encoding is used. No manual setting will be required. The camera will switch to **Auto** automatically when an encoded Leica M lens is attached, regardless of the original lens setting.

USING A LEICA M LENS WITHOUT 6-BIT ENCODING

The lens type must be entered manually when using a Leica M lens without 6-bit encoding.

- ▶ Select **Lens Detection** in the main menu
- ▶ Select **Manual M**
- ▶ Select the attached lens from the list
 - The lenses are listed with their focal length, apertures and item number.

Notes

- Many lenses have their item number engraved on the opposite side of the depth of field scale.
- The list also includes lenses that used to be available without encoding (pre-June 2006). Newer lenses are all provided with encoding and can therefore be automatically detected.
- When using the Leica Tri-Elmar-M 16-18-21 f/4 ASPH., the set focal length is not transferred to the camera housing will therefore also not be included in the Exif picture dataset. You can, however, enter the focal length manually.
- Tri-Elmar-M 28-35-50 f/4 ASPH., on the other hand, comes equipped with the means for mechanical transmission of the set focal length to the camera need for mirroring the correct bright-line frame in the viewfinder. The focal length is scanned by the camera electronics and the information is used for focal length-specific corrections. Due to space limitations, the menu only contains an item number (11 625). The two other variants – 11 890 and 11 894 – can be used as well and the menu settings will apply.

USING A LEICA R LENS

The lens type must also be entered manually when attaching a Leica R lens via the Leica R adapter. The camera will automatically switch to **Manual R** when a Leica R lens is attached, no matter what setting existed originally. You will have to select the lens type from the list.

- ▶ Select **Lens Detection** in the main menu
- ▶ Select **Manual R**
- ▶ Select the attached lens from the list

DISABLING LENS DETECTION

Lens detection can optionally be disabled completely. That makes sense if the recording will not be automatically corrected (DNG and JPG) to maintain the characteristic recording features of a lens.

- ▶ Select **Lens Detection** in the main menu
- ▶ Select **Off**

Note

- No lens information will be written to the Exif (Exchangeable Image File Format) data of the recording when lens detection is disabled.

DIOPTER ADJUSTMENT

A diopter compensation function for up to ± 3 diopter is available to allow glasses wearers the use of this product without eye glasses. The rangefinder can be fitted with an optional Leica correction lens for that purpose.

us.leica-camera.com/Photography/Leica-M/Technical-Equipment/Viewfinder-Accessories/Correction-lenses

- ▶ Attach the correction lens flat against the viewfinder eyepiece
- ▶ Hand-tighten in clockwise direction

Notes

- Please note the information provided on the Leica homepage for the selection on an appropriate correction lens.
- Please note that the viewfinder of the Leica M10-R is set to -0.5 diopter as standard. If you wear eye glasses with 1 diopter, you will therefore need a correction lens with $+1.5$ diopter.

CAMERA OPERATION

CONTROL ELEMENTS

MAIN SWITCH

The main switch switches the camera on and off.

SWITCHING THE CAMERA ON

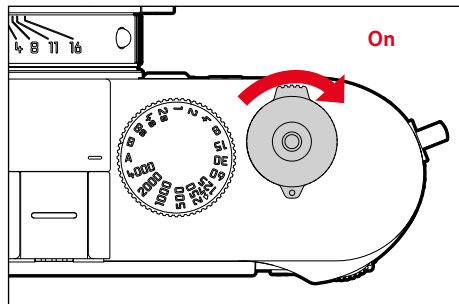

Notes

- Once switched on, the camera will be ready to use after approx. 1 s.
- The LED lights up briefly and the displays in the viewfinder appear.

SWITCHING THE CAMERA OFF

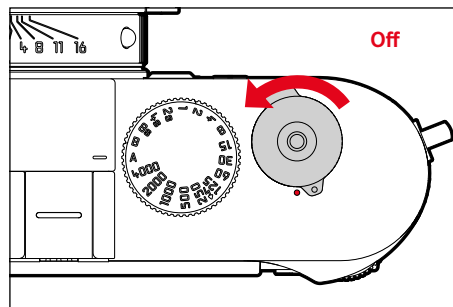

Note

- The function **Auto Power Saving** (see p. 57) deactivates the camera automatically if no operation occurs within a preset time. Use the main switch to deactivate the camera if this function is **Off** to prevent inadvertent exposures and battery discharge when the camera is not in use.

SHUTTER BUTTON

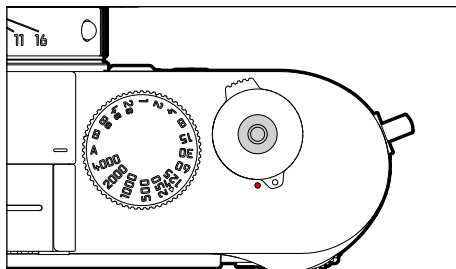

The shutter button works in two stages.

1. **Tapping** (= Pressing the shutter button to the 1st pressure point)
 - Activating the camera electronics and displays
 - Metering memory lock (metering & saving):
 - saves the metered exposure value in aperture priority mode, i.e. the shutter speed calculated by the camera
 - Restarting a running self-timer delay time
 - Return to picture mode
 - from review mode
 - from menu control
 - from standby mode

2. **Press down fully**

- Shutter release
 - The data is then transferred to the memory card.
- Starting a preselected self-timer delay
- Starting a picture series or interval shooting

Notes

- Press down the shutter button in a smooth motion until you hear the click of the shutter to prevent camera shake.
- The shutter button remains locked:
 - if the memory card inserted and/or the internal buffer memory are (temporarily) full
 - if the battery has exceeded its performance limits (capacity, temperature, age)
 - if the memory card is write-protected or damaged
 - if the sensor is too hot

SHUTTER SPEED SETTING DIAL

The shutter speed setting dial has no stop, which means it can be turned in either direction from any position. It will click at each engraved position and for intermediate values. Intermediate positions outside the click positions must not be used. Please read the section “Exposure” (see p. 74) for details about exposure settings.

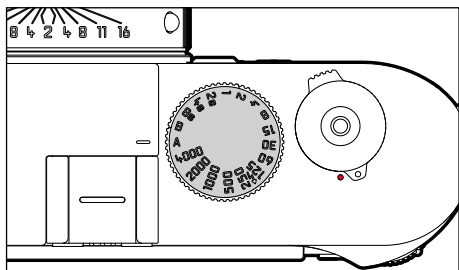

- **A**: Aperture priority (automatic shutter speed control)
- **4000 - 8 s**: Fixed shutter speeds of 1/4000 s to 8 s (with intermediate values, clicking in 1/2 increments)
- **B**: Long-term exposure (bulb)
- **⚡**: The shortest possible sync speed (1/180 s) for flash mode

ISO SETTING WHEEL

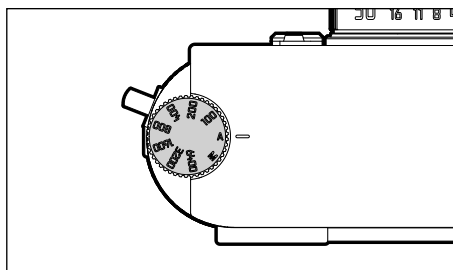

- **A**: Automatic ISO sensitivity control
- **100 - 6400**: Fixed ISO values
- **M**: Manual ISO sensitivity control

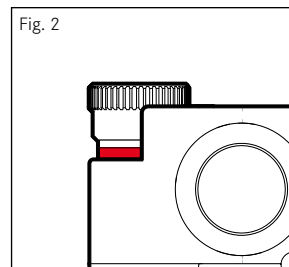
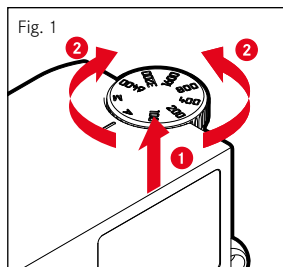

- ▶ Push the ISO setting wheel up until you feel it clicking into place and the red line (fig. 2) is visible
- ▶ Turn the setting wheel to the desired value
- ▶ Push down the ISO setting wheel

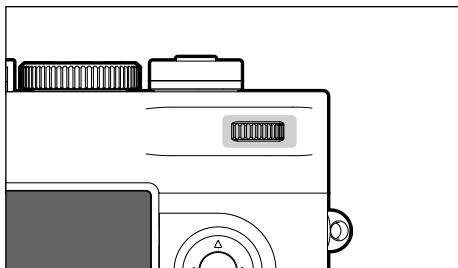
THUMBWHEEL

- Menu navigation
- Exposure compensation value selection
- Enlarging/reducing viewed pictures
- Setting selected menu items/functions
- Scrolling through the picture memory

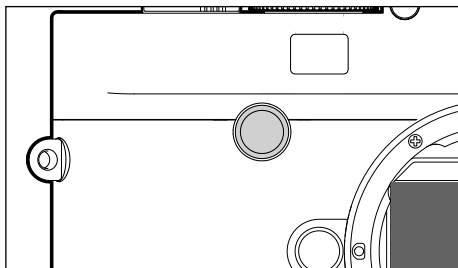
FOCUS BUTTON

- Focus aid activation

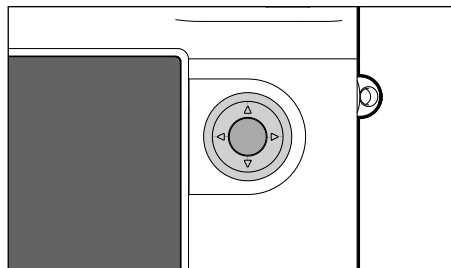
DIRECTIONAL PAD/CENTER BUTTON**DIRECTIONAL PAD**

- Menu navigation
- Setting selected menu items/functions
- Scrolling through the picture memory

CENTER BUTTON

- Accessing the status display
- Applying menu settings
- Display of settings/data when recording
- Display of picture data during review

LV BUTTON/PLAY BUTTON/MENU BUTTON

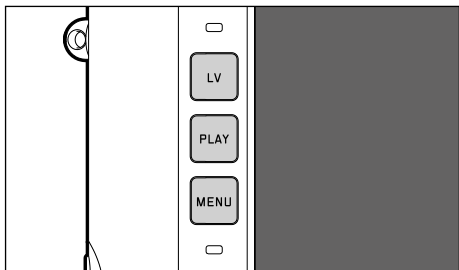

LV BUTTON

- Activating/deactivating the Live View mode

PLAY BUTTON

- Activation and deactivation of the (continuous) review mode
- Return to full-screen display







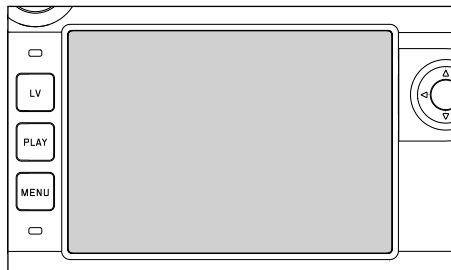

MENU BUTTON

- Accessing the **FAVORITES** or **MAIN MENU**
- Accessing the review menu
- Exiting the currently displayed (sub) menu

LCD PANEL



- Display of most important current settings
- Quick access to some menus
- Touch control

TOUCH CONTROL*		in Picture mode (LV mode)	in review mode
	tap briefly	Shifting the metering field	Select the recording Hide/show info displays
	double tap	Focus aid activation	Enlarging/reducing viewed pictures
	swipe	Shifts the enlarged image section	Scrolling through the picture memory Shifts the enlarged image section
	horizontal swipe (full length)		
	vertical swipe (full length)		
	touch and hold		
	two-finger pinch/ spread		Enlarging/reducing viewed pictures
	swipe and hold/ hold and swipe		

* A light touch is enough, don't apply pressure.

MENU CONTROL

Menu sections: **MAIN MENU** and **FAVORITES**

MAIN MENU:

- contains all menu items

FAVORITES:

- your custom list (see p. 54 for details on how to manage this list)

CONTROL ELEMENTS

The following elements are used for menu control.



18 LV button

19 **PLAY** button

20 **MENU** button

16 Thumbwheel

23 Directional pad

24 Center button

MENU SECTIONS

FAVORITES MENU

The favorites menu offers quick access to the most frequently used menu items. It can contain up to 15 menu items. These can be assigned individually (see p. 54).



MAIN MENU

The main menu offers access to all settings. Most of these are organized in submenus.

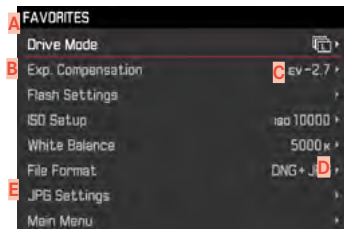

- A** Menu sections: MAIN MENU / FAVORITES
- B** Menu item name
- C** Menu item setting
- D** Submenu reference
- E** Scrollbar: current position in the menu list

Note

- Some menu items can only be accessed under specific circumstances. The text in the relevant line is displayed in gray to signify the existence of a submenu.

SUBMENU

There are various types of submenus available. The following pages describe their operation.



- F** Current menu item
- G** Submenu item
- H** References to other submenus
- I** Scrollbar

Note

- In some cases, an additional scale will be available, where values can be set or function options can be selected.

MENU NAVIGATION

DISPLAY “HOME” SCREEN (INITIAL MENU CONTROL SCREEN)

if there are no menu items assigned to the favorites menu:

- ▶ Press the **MENU** button 1x
 - **MAIN MENU** appears.

if at least one menu item was assigned to the favorites menu:

- ▶ Press the **MENU** button 1x
 - **FAVORITES** menu appears.

Switching from **FAVORITES** to **MAIN MENU**

- ▶ Select **Main Menu** (last item in the favorites menu)
- or

- if the favorites menu consists of one page:
 - ▶ Press the **MENU** button 1x
- if the favorites menu consists of 2 pages:
 - ▶ Press the **MENU** button 2x

Switching from **MAIN MENU** to **FAVORITES**

- ▶ Press the directional pad left

Note

- **MAIN MENU** and **FAVORITES** are accessible only in recording mode.

SCREEN BY SCREEN NAVIGATION

Scrolling forward

- ▶ Press the **MENU** button
 - Screen 1 of the main menu will be displayed again after Screen 4.

LINE BY LINE NAVIGATION

(Function/function option selection)

- ▶ Press the directional pad up/down
- or
- ▶ Turn the thumbwheel
(to the right = down, to the left = up)
 - Once the last menu item has been reached scrolling up or down, the display will automatically jump to the previous or next screen. The currently active menu section (**FAVORITES**, **MAIN MENU**) is not exited.

SHOW SUBMENU

- ▶ Press the center button
- or
- ▶ Press the directional pad to the right

CONFIRM SELECTION

- ▶ Press the center button
 - The screen image changes back to the active menu item. The set function variant is shown on the right in the relevant menu line.

Note

- No confirmation is needed for the selection of **On** or **Off**. An automatic save is done.

GO BACK ONE STEP

(Return to the superordinate menu item)

- ▶ Press the directional pad left
 - This option is only available for list-type submenus.

or

- ▶ Press the **MENU** button 1x

EXITING THE MENU

You can exit the menus and submenus at any time – with/without applying the settings selected there.

go to picture mode

- ▶ Tap the shutter button

go to review mode

- ▶ Press the **PLAY** button

SUBMENU

KEYBOARD/NUMBER PAD

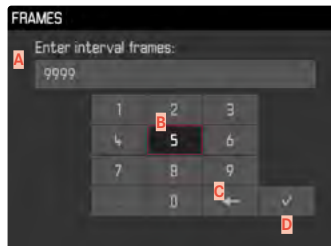

- A** Entry line
- B** Keyboard/Number pad
- C** "Delete" button (deletes the last character entered)
- D** "Confirm" button
(to apply individual values and existing settings)
- E** Shift key (toggles between upper and lower case letters)
- F** Changing the character type

SELECTING A BUTTON (ICON/FUNCTION BUTTON)Using button control

- ▶ Press the directional pad left or right as needed
 - The currently active button will be highlighted.

or

- ▶ Turn the thumbwheel
 - The currently active button will be highlighted.
 - There will be an automatic jump to the next/previous line when the end/beginning of the line is reached.
- ▶ Press the center button

Using touch control

- ▶ Press the button of your choice

SAVE

- ▶ Select button **D**

CANCEL

- ▶ Press the **MENU** button

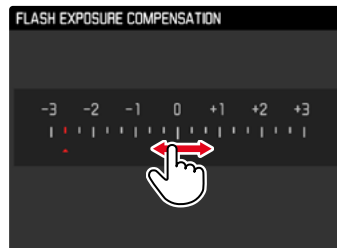
SCALE MENUUsing button control

- ▶ Press the directional pad left/right
- or
- ▶ Turn the thumbwheel

Using touch control

- ▶ Select the desired setting directly or swipe

Notes

- The currently active setting displayed in the center is highlighted in red.

DATE/TIME MENU

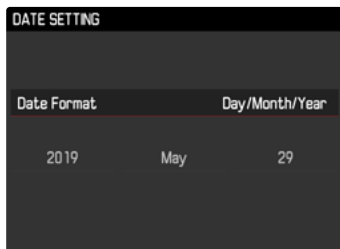

To move to the next settings field

- ▶ Press the directional pad left/right or
- ▶ Press the center button

To set values

- ▶ Press the directional pad up/down or
- ▶ Turn the thumbwheel

To save and return to superordinate menu item

- ▶ Press the center button on the last setting field

COMBI MENU



The setting of the individual menu items is done via a setting bar in the lower display area.

To access individual menu items

- ▶ Press the directional pad up/down

To set individual items

- ▶ Press the directional pad left/right or
- ▶ Turn the thumbwheel

To apply the setting

- ▶ Press the center button

To return to the superordinate menu item

- ▶ Press the **MENU** button

QUICK ACCESS

FAVORITES MENU

Assign your most frequently used menu items to a favorites menu (up to 15 items) for quick and easy access. The available functions are shown in the list on p. 132.

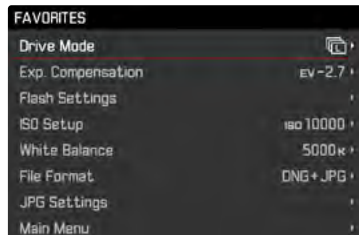

MANAGING THE FAVORITES MENU

- ▶ Select **Customize Control** in the main menu
- ▶ Select **Edit Favorites**
- ▶ Select the desired menu item



- ▶ Select **On/Off**
 - A warning message appears when the favorites menu has reached the maximum of 15 menu items and no further items can be added.

Note

- The favorites menu will be deleted completely if all menu items are set to **Off**.

VIA THE STATUS SCREEN



In addition to providing an overview of the most important settings, the status screen also allows quick access to specific menu functions.

Accessing the status screen

- ▶ Press the center button

Accessing a menu function

- ▶ Touch the field with the desired function

Returning to the status screen

- ▶ Press the **MENU** button

Returning to recording mode

- ▶ Tap the shutter button

Note

- The status screen is not available in LV mode.

DIRECT ACCESS

Assign a menu function to the thumbwheel for extra quick operation: [Exp. Compensation](#) or [LV Zoom](#). The setting has no impact on the function if focus assist tools are in use.

- ▶ Select [Customize Control](#) in the main menu
- ▶ Select [Customize Wheel](#)
- ▶ Select [Exp. Compensation/LV Zoom](#) or [Off](#)

CAMERA BASIC SETTINGS

For details on how to navigate in the menus and for inputs see chapter "Menu control" (see p. 48).

- The two menu items **Language** and **Date & Time** appear automatically when switching the camera on for the first time, after a factory reset (see p. 118) or after a firmware update.

MENU LANGUAGE

Factory setting: English

Available menu languages: German, French, Italian, Spanish, Portuguese, Russian, Japanese, Korean and Traditional or Simplified Chinese

- ▶ Select **Language** in the main menu
- ▶ Select your language
 - Aside from a few exceptions, the language will be changed for all information.

DATE/TIME

DATE

You can choose one of 3 options.

- ▶ Select **Date & Time** in the main menu
- ▶ Select **Date Setting**
- ▶ Select the desired date format
(**Day/Month/Year**, **Month/Day/Year**, **Year/Month/Day**)
- ▶ Set the date

TIME

- ▶ Select **Date & Time** in the main menu
- ▶ Select **Time Setting**
- ▶ Select the desired brightness
(**12 Hours**, **24 Hours**)
- ▶ Set the time
(Select **am** or **pm** for the 12-hour format)

AUTOMATIC TIME VIA GPS

- ▶ Select **GPS** in the main menu
- ▶ Select **On**
- ▶ Select **Date & Time** in the main menu
- ▶ Select **Auto GPS Time**
- ▶ Select **On**

TIME ZONE

- ▶ Select **Date & Time** in the main menu
- ▶ Select **Time Zone**
- ▶ Select your time zone/current location

DAYLIGHT SAVING TIME

- ▶ Select **Date & Time** in the main menu
- ▶ Select **Daylight Saving Time**
- ▶ Select **On/Off**

Notes

- **Auto GPS Time** is available only with an attached Leica Visoflex (optional accessory) with activated GPS function. The menu item will otherwise be grayed out and unavailable for settings.
- **Time Zone** and **Daylight Saving Time** are available only if the GPS function is set to OFF.

POWER SAVE MODE (STANDBY MODE)

The camera will switch to the power-saving standby mode after a preset time to extend battery life if this function is activated.

Factory setting: **2 minutes**

- ▶ Select **Auto Power Saving** in the main menu
- ▶ Select the desired setting
(**2 minutes**, **5 minutes**, **10 minutes**, **Off**)

Note

- The camera can be woken from standby mode at any time by pressing the shutter button or by switching the main switch off and on again.

STATUS LED

The status LED indicates a variety of camera processes when the device is in its factory settings (incl. when processes like Save, Zoom in/Zoom out and Delete are applied to a recording). This function can be deactivated for most processes (except for camera ON/OFF).

- ▶ Select **Customize Control** in the main menu
- ▶ Select **LED**
- ▶ Select the desired setting
(**Enable**, **Disable**)

DISPLAY/VIEWFINDER SETTINGS

The camera comes equipped with a 3" liquid crystal color panel, which is protected by a glass cover made of extremely hard and scratch-resistant Gorilla® glass.

In picture mode and with active Live View function, the screen displays the image captured by the sensor via the attached lens. In review mode, the images saved on the memory card are displayed on the screen. In both cases, the screen shows the entire image field, as well as the selected data and information. When using the rangefinder, you can press the center button to call up the status screen, which displays a selection of settings (see p. 55).

The following functions can be configured and used individually:

- Brightness
- Information display

BRIGHTNESS

RANGEFINDER

The brightness sensor automatically adjusts rangefinder brightness.

Note

- This automatic control is not available for Leica M lenses with viewfinder attachments, as they cover the brightness sensor that supplies the required information. The frames and displays will therefore be displayed at a constant brightness when Leica M lenses are used.

LCD PANEL

You can adjust brightness for best visibility in various lighting conditions.

- ▶ Select **Display Brightness** in the main menu
- ▶ Select the desired brightness of **Auto**

LEICA VISOFLEX (EVF)

An electronic viewfinder (EVF) can be attached to the Leica M10-R via its accessory shoe. Leica Visoflex is an optional extra and offers the following functions:

- Swivel function for easy photography with various angles
- Applying screen settings
- Transfer of GPS data to the camera (see p. 56 and 116)
- Diopter adjustment

The settings described below will only take effect if Leica Visoflex is attached.

us.leica-camera.com/Photography/Leica-M/Technical-Equipment/Viewfinder-Accessories/Visoflex

BRIGHTNESS

The brightness in the EVF is set independently of the brightness selected for the LCD panel.

- ▶ Select **EVF Brightness** in the main menu
- ▶ Select the desired brightness of **Auto**

LCD PANEL/EVF USE

The electric viewfinder can take on a variety screen of functions. The displays appearing on screen and in the electronic viewfinder are identical.

You can preset the types of situations in which the EVF or the LCD panel should show the displays. An eye sensor on the Visoflex will switch the display from screen to viewfinder automatically if **Auto** is selected. The settings for Preview, Playback/Review and LV mode are done separately.

Note

- Select **EVF** if you want to keep the LCD panel switched off (e.g. on dark environments).

MENU CONTROL FOR PLAYBACK/REVIEW MODE

Factory setting: **Auto**

Specifies the display to be used in Playback/Review mode, as well as for displaying the menu.

- ▶ Select **EVF/Display Control** in the main menu
- ▶ Select **Play Screen Target**
- ▶ Select the desired setting
(**Auto**, **EVF**, **Display**)

LIVE VIEW MODE (RECORDING MODE)

Factory setting: **Auto**

Specifies the display to be used in Live View mode.

- ▶ Select **EVF/Display Control** in the main menu
- ▶ Select **LV Screen Target**
- ▶ Select the desired setting
(**Auto**, **EVF**, **Display**)

Note

- See p. 67 about **LV disabled**.

AUTO REVIEW

Factory setting: **Auto**

Specifies the display to be used to preview the most recent recording (**Auto Review**).

- ▶ Select **EVF/Display Control** in the main menu
- ▶ Select **Auto Review Screen Target**
- ▶ Select the desired setting
(**Auto**, **EVF**, **Display**)

BASIC PICTURE SETTINGS

FILE FORMAT

Choose the JPG format **JPG** or the standardized raw data format **DNG** (= Digital Negative). These can be used individually or simultaneously.

Factory setting: **DNG**

- ▶ Select **File Format** in the main menu
- ▶ Select a format
(**DNG**, **DNG+JPG**, **JPG**)

Notes

- The standardized DNG (Digital Negative) format is used for the storage of raw picture data.
- When picture data is saved in **DNG** and in **JPG** format simultaneously, then the resolution setting for the **JPG** format will be used for the JPG file.
- The **DNG** format always works with the highest available resolution, no matter what **JPG** setting is selected.
- The remaining number of frames shown in the LCD panel will not necessarily change after every picture taken. That very much depends on the object; very fine image structures result in higher data quantities, while homogeneous surfaces mean less data.

JPG SETTINGS

The functions and settings described in this section apply for pictures in **JPG** format only.

RESOLUTION

The **JPG** format setting offers 3 image resolution (number of pixels) options: **L-JPG**, **M-JPG** and **S-JPG**. This choice allows an alignment with the intended use and available memory card capacity.

Factory setting: **L-JPG**

- ▶ Select **JPG Settings** in the main menu
- ▶ Select **JPG Resolution**
- ▶ Select the desired resolution
(**L-JPG (40 MP)**, **M-JPG (20 MP)**, **S-JPG (6 MP)**)

IMAGE PROPERTIES

One of the many advantages of digital photography is that it is very easy to change important image properties. You can manipulate contrast, sharpness and toning before recording a picture.

CONTRAST

Contrast, i.e. the difference between light and dark image sections, determines whether an image comes across as "flat" or "brilliant". Increasing or decreasing this difference impacts on contrast, meaning that some image sections are rendered with more or less light.

Factory setting: **Standard**

- ▶ Select **JPG Settings** in the main menu
- ▶ Select **Contrast**
- ▶ Select the desired level
(**Low**, **Standard**, **High**)

SHARPNESS

The impression of sharpness in a picture is largely determined by edge sharpness, i.e. by how slight the transition area between light and dark is at edges in the picture. Expanding or reducing these areas will therefore change the impression of sharpness.

Factory setting: **Standard**

- ▶ Select **JPG Settings** in the main menu
- ▶ Select **Sharpness**
- ▶ Select the desired level
(**Low**, **Standard**, **High**)

COLOR SATURATION

The saturation factor in color images determines, whether colors in the picture appear "pale" and pastel-like or "vivid" and colorful. While lighting conditions and weather (e.g. foggy/clear) are a given in terms of recording conditions, their rendering can be influenced. Factory setting: **Standard**

- ▶ Select **JPG Settings** in the main menu
- ▶ Select **Saturation**
- ▶ Select the desired level
(**Low**, **Standard**, **High**)

MONOCHROME PHOTOGRAPHY

You can choose to save your images in color or monochrome, provided you take the pictures in JPG format.

- ▶ Select **JPG Settings** in the main menu
- ▶ Select **Monochrome**
- ▶ Select **On/Off**

Note

- The **Saturation** setting is unavailable for **Monochrome** images and is therefore grayed out.

PICTURE MODE

DRIVE MODE

As a rule, the functions and settings described in the following refer to the recording of individual pictures. The Leica M10-R offers a number of other picture modes in addition to single frame shots. Please read the relevant sections for information about functionalities and setting options.

- ▶ Select **Drive Mode** in the main menu
- ▶ Select the desired function options

Mode	Setting options/variants
Single frame shot	Single
Serial exposures (see p. 84)	Speed: - Continuous Low Speed - Continuous High Speed
Self-timer (see p. 87)	Delay time: - Self Timer 2 s - Self Timer 12 s
Interval shooting (see p. 85)	Frames Interval between shots (Interval Time)
Exposure bracketing (see p. 86)	Frames (3 or 5) F-Stops Exp. Compensation

IMAGE TYPES

USING THE RANGEFINDER

IMAGE FIELD (BRIGHT-LINE FRAME)

The bright-line rangefinder of this camera is not just a very high-quality, large, brilliant and bright viewfinder – it also doubles as a highly precise, lens-coupled metering device. All Leica M lenses with focal lengths between 16 and 135 mm are coupled automatically when they are attached to a camera. The viewfinder has a magnification factor of 0.73x.

The bright-line frame is coupled with the focusing function in such a way that the parallax – the offset between the lens axis and the viewfinder axis – is compensated automatically. At ranges under 2 m, the sensor captures slightly less than indicated by the inner edges of the bright-line frame, and slightly more at longer ranges (see adjacent diagram). These slight, in practical terms never important deviations are unavoidable. The bright-line frames of a camera with viewfinder must be adjusted to the view angle of the focal length of the lens. The nominal view angle changes slightly when focusing due to the changing draw-out, i.e. the distance of the lens system to the sensor level. When the set distance is below infinity (and the draw-out accordingly greater), the actual view angle also decreases – the lens captures less of the image object. The view angle differences at greater focal lengths tend to be larger due to the greater draw-out.

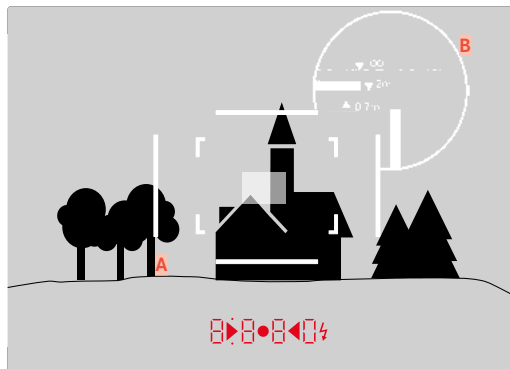

All pictures and bright-line frame positions at 50 mm focal length

A	Bright-line frame
B	Actual image field
set to 0.7 m	The sensor captures around one frame width less
set to 2 m	The sensor captures the exact image field shown within the inner edges of the bright-line frame
Set to infinity	The sensor detects around 1 or 4 (vertical or horizontal) frame width(s) more

Notes

- The bright-light frames illuminated by white light LEDs appear alongside the exposure meter LEDs at the lower edge of the viewfinder image, once the camera electronics are activated.
- The rectangular distance measuring field, which is brighter than the surrounding metering field, is in the center of the viewfinder frame. Please read the relevant sections for more information about distance and exposure metering.

The relevant bright-line frame will light up in the combinations 35 mm + 135 mm, 50 mm + 75 mm or 28 mm + 90 mm when lenses with a focal length of 28 (Elmarit as of serial number 2 411 001), 35, 50, 75, 90 and 135 mm are used.

35 mm + 135 mm

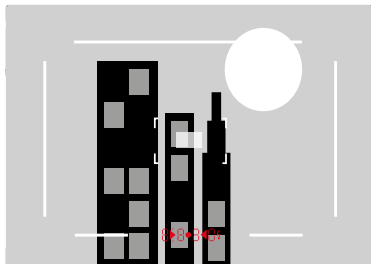

50 mm + 75 mm

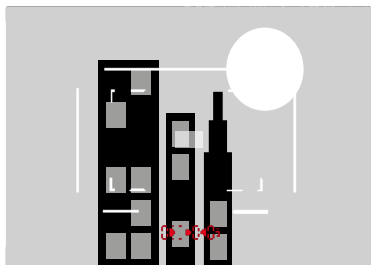

28 mm + 90 mm

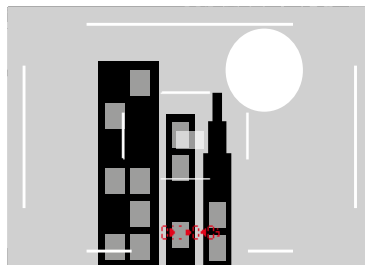

SHOW ALTERNATIVE IMAGE RANGES/FOCAL LENGTHS

Additional bright-line frames may be displayed depending on the attached lens. These allow a simulation of the relevant focal lengths. This process helps in the selection of the right lens for the desired image range.

- ▶ Push the image field selector towards the lens
 - The image field selector will snap back automatically when released.

LIVE VIEW MODE

The Live View mode allows viewing the image object on the LCD panel while the picture is taken. The image is shown exactly as it is rendered by the attached lens.

LIVE VIEW MODE ON/OFF

- ▶ Press the **LV** button

PERMANENT DEACTIVATION OF LIVE VIEW MODE

Live View mode can be permanently disabled. Pressing the **LV** button will then have no effect.

- ▶ Select **EVF/Display Control** in the main menu
- ▶ Select **LV Screen Target**
- ▶ Select **LV disabled**

Notes

- Live View mode is based on the image captured by the sensor. The camera must control the shutter. Shutter control is audible and may result in a slight delay in shutter release.
- The camera will warm up when Live View mode is used for an extended period of time. Power consumption will simultaneously increase.
- Alternating current causes brightness fluctuations invisible to the human eye in many light sources. This may result in a flickering of the Live View screen image due to the sensitivity and scan rate of the image sensors. Picture quality will not be impacted. The effect can be avoided by selecting a slower shutter speed.

FOCUSING

Various assist functions are provided for focusing, depending on whether you use the camera's rangefinder or Live View mode.

VIA RANGEFINDER

The rangefinder of this camera is very precise due to its wide and effective measurement base. Image sharpness can be set via the superimposed image or the split image method.

SUPERIMPOSED IMAGE METHOD (DOUBLE IMAGE)

For a portrait, you might focus on the eyes using the metering field of the rangefinder, turning the focus ring on the lens until the contours are aligned exactly inside the metering field.

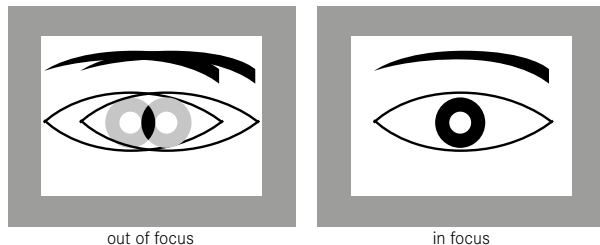

SPLIT IMAGE METHOD

For an architectural photograph, you might aim the metering field of the rangefinder at e.g. the vertical edge or any other clearly defined vertical line and keep turning the focus ring on the lens until the edge contour or the line is visible at the outer edges of the metering field without any offset.

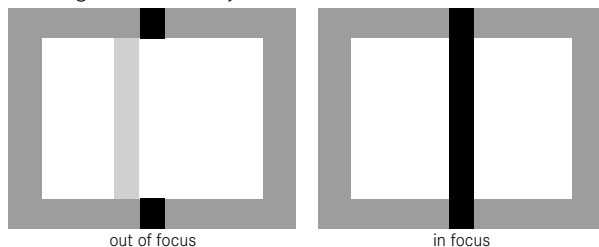

Notes

- Very precise distance measurements are particularly beneficial when using wide-angle lenses with a relatively large depth of field.
- The metering field of the rangefinder is displayed as a bright, sharp-edged rectangle in both methods. The position of the metering field cannot be changed. It will always be at the center of the viewfinder.

IN LIVE VIEW MODE (WITH ASSIST FUNCTIONS)

You can set the image sharpness in Live View mode via the screen image – it will show the image object at the exact sharpness as it is rendered by the lens based on the distance and aperture setting.

Your camera offers two useful assist functions to facilitate and improve setting accuracy:

- The magnification of an (initially) central cropped section of the screen image (Zooming).
- Marking of screen image sections where subject elements are in clear focus (Focus Peaking)

The functions can be automatically activated during focusing or can be accessed independently.

FOCUS PEAKING

This assist function highlights the edges of in focus subject elements in color. The color can be user-specified.

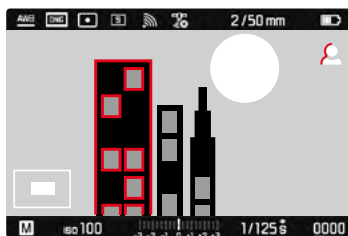

- ▶ Select **Capture Assistants** in the main menu
- ▶ Select **Focus Peaking**
- ▶ Select the desired setting
(Off, Red, Blue, Green, White)
- ▶ Select an image section
- ▶ Turn the focus ring to mark the desired subject elements
 - All subject elements that are rendered in focus with the selected distance setting are marked with a silhouette in the selected color.

Notes

- Focus peaking is based on object contrast, i.e. differences between light and dark of the subject elements. As a result, high contrast subject elements could be marked, even if they are not completely in focus.
- Display accuracy decreases when a wide-angle lens is used with a small aperture (= high depth of field).

ENLARGEMENT

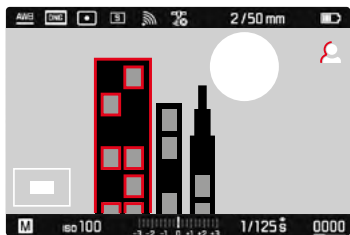

The larger the details of the object are shown, the better you can assess their sharpness and the more accurately you can focus. When Spot Metering is in use, the position of the cropped section is dictated by the position of the metering field. In all other exposure metering methods, the position is represented by cross hairs. Both can be moved to the desired position beforehand using touch control or the directional pad. Use the thumbwheel to choose one of two magnification factors. The most recently used function and zoom factor will still be set the next time the function is accessed.

Adjusting the enlargement function

- ▶ Turn the thumbwheel

Changing the position of the enlarged section



- ▶ Swiping will allow you to move the position of an enlarged cropped section

or

- ▶ Press the directional pad left or right as needed

ACCESSING ASSIST FUNCTIONS

In the image at the bottom left, the position and zoom level of the displayed cropped section is shown. The cropped section displayed can also be unenlarged. The most recently used zoom level is used each time assist functions are accessed.

When Focus Peaking is activated,  will appear to the right of the frame with a display of the color used.  appears if Focus Peaking is off.

The assist functions can be shown or hidden at any time independent of the focus setting.

Accessing the assist functions

- ▶ Press the focus button
- or
- ▶ Double tap the LCD panel at the desired position

Deactivating the assist functions

Manually accessed assist functions remain active until they are deactivated.

- ▶ Press the focus button
- or
- ▶ Double tap the LCD panel
- or
- ▶ Tap the shutter button

VIA THE FOCUS RING

Assist functions can also be accessed automatically during focusing.

- ▶ Select **Capture Assistants** in the main menu
- ▶ Select **Focus Aid**
- ▶ Select **Automatic**

Accessing the assist functions

- ▶ Turn the focus ring

Preventing automatic activation

- ▶ Select **Capture Assistants** in the main menu
- ▶ Select **Focus Aid**
- ▶ Select **Manual**

Note

- The assist functions deactivate automatically about 5 s after the last turn of the focus ring. That does not apply if the magnification level was changed.

VIA THE THUMBWHEEL

The assist functions can additionally be accessed via the thumbwheel.

- ▶ Select **Customize Control** in the main menu
- ▶ Select **Customize Wheel**
- ▶ Select **LV Zoom**
- ▶ Turn the thumbwheel to the right
 - The assist functions are activated.

ISO SENSITIVITY

The ISO setting covers a range between ISO 100 and ISO 50000, allowing you to adapt to the relevant situation as required. There is more leeway for the use of preferred shutter speed and aperture combinations when setting the exposure manually. You can set priorities within the scope of the automatic setting, e.g. for reasons of picture composition.

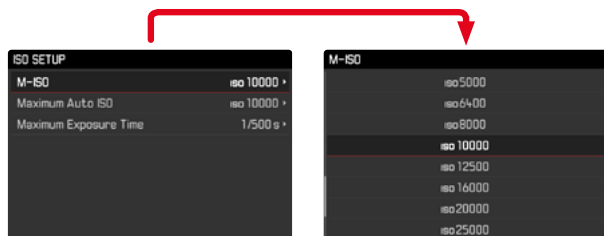

Choose a click value engraved on the ISO setting wheel or the positions:

- **M**: for intermediate values, as well as for higher values
- **A**: for automatic setting; values between ISO 100 and 50000 will be used

FIXED ISO VALUES

VALUES ENGRAVED ON THE ISO SETTING WHEEL

- ▶ Turn the ISO setting wheel to the desired value
(**100, 200, 400, 800, 1600, 3200, 6400**)

ALL AVAILABLE SETTINGS

Values between ISO 100 and ISO 50000 can be selected in 28 increments.

Factory setting: **ISO 100**

- ▶ Set the ISO setting wheel to **M**
- ▶ Select **ISO Setup** in the main menu
- ▶ Select **M-ISO**
- ▶ Select the desired value

Note

- When high ISO values are used or the image is edited later, image noise, as well as vertical and horizontal stripes may become visible, particularly in larger, evenly lit areas of the object.

AUTOMATIC SETTING

The camera automatically adjusts the sensitivity to ambient brightness and/or to the configured shutter speed/aperture settings combination. In conjunction with aperture priority mode, this function extends the range for automatic exposure control.

- ▶ Set the ISO setting wheel to **A**

or

- ▶ Set the ISO setting wheel to **M**
- ▶ Select **ISO Setup** in the main menu
- ▶ Select **M-ISO**
- ▶ Select **ISO Auto**

LIMITING SETTING RANGES

A max. ISO value can be set, which will then limit the automatic setting range (**Maximum Auto ISO**). A max. exposure time can also optionally be configured. There are focal length-related settings (**1/f**, **1/(2f)**, **1/(4f)**)¹ and fixed max. shutter speeds between **1/2 s** and **1/500 s** available for that purpose.

In the focal length-specific settings, the camera will only switch to a higher sensitivity if the shutter speed would fall below the set threshold due to low light; for example with a 50 mm lens at speeds slower than **1/60 s** at **1/f**, **1/125 s** at **1/(2f)** or **1/250 s** at **1/(4f)**.

Separate settings are available for flash photography.

LIMITING ISO VALUES

All values from ISO 125 are available.

Factory setting: **1600**

- ▶ Select **ISO Setup** in the main menu
- ▶ Select **Maximum Auto ISO**
- ▶ Select the desired value

LIMITING SHUTTER SPEED RANGES

Factory setting: **1/f**

- ▶ Select **ISO Setup** in the main menu
- ▶ Select **Maximum Exposure Time**
- ▶ Select the desired value
(**1/f**, **1/(2f)**, **1/(4f)**, **1/500 s**, **1/250 s**, **1/125 s**, **1/60 s**, **1/30 s**, **1/15 s**, **1/8 s**, **1/4 s**, **1/2 s**)

LIMITING SHUTTER SPEED RANGES (FLASH)

Factory setting: **1/f**

- ▶ Select **Flash Settings** in the main menu
- ▶ Select **Max. Flash Sync. Time**
- ▶ Select the desired value
(**1/f**, **1/(2f)**, **1/(4f)**, **1/125 s**, **1/60 s**, **1/30 s**, **1/15 s**, **1/8 s**, **1/4 s**, **1/2 s**)

¹ This function requires the use of encoded lenses or the setting of the lens type used in the menu.

WHITE BALANCE

In digital photography, White Balance ensures neutral color rendering in any light. White Balance relies on the setting made in the camera, which light color is to be rendered as 'white'.

Four methods are available:





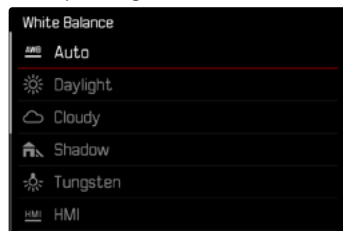



- automatic control
- fixed presets
- manual setting via metering
- direct setting of the color temperature

Factory setting: **Auto**



AUTOMATIC CONTROL/FIXED SETTINGS

- **Auto**: for automatic control, which delivers neutral results in most situations
- Various fixed presets for most frequently encountered light sources:

 Daylight	for outdoor pictures in sunlight
 Cloudy	for outdoor pictures in cloudy conditions
 Shadow	for outdoor pictures with the main subject in shadow
 Tungsten	for indoor pictures with (predominantly) incandescent lamp light
 HMI	for indoor pictures with (predominantly) light from metal halide lamps
 Fluorescent Warm:	for indoor pictures with (prevailing) light from fluorescent tubes with warm light color
 Fluorescent Cool:	for indoor pictures with (prevailing) light from fluorescent tubes with cool light color
 Flash	for flash photography

- ▶ Select **White Balance** in the main menu
- ▶ Select the desired setting

MANUAL SETTING VIA METERING

Gray Card

This metering variant captures only the color hue metered within the metering field and calculates the mean gray value from it.

- ▶ Select **White Balance** in the main menu
- ▶ Select  **Gray Card**
 - A message appears on the LCD panel:
Please take a picture for setting the white balance.
- ▶ Shutter release
 - Make sure that the image field includes a white or neutral gray (reference) area.
 - The following appears on the LCD panel:
 - the image based on automatic White balance
 - a cross in the center of the image



Moving the metering field

- ▶ Press the directional pad left or right as needed

Taking measurements

- ▶ Aim the metering field at a white or neutral gray area
- ▶ Press the center button
 - The image preview is displayed. The color rendering is adjusted according to the White Balance setting.
 - once the color is rendered to your satisfaction
 - ▶ press the center button a second time
 - The setting will now be saved.
 - the color is not rendered to your satisfaction
 - ▶ retake your measurements at a different point in the image field

Creating a new image for White Balance

- ▶ Press the **MENU** button

Canceling the measurement

- ▶ Tap the shutter button

Note

- A value configured using this method will remain unchanged (i.e. it will be used for all subsequent photographs) until new measurements are taken or one of the other white balance settings is selected.

DIRECT SETTING OF THE COLOR TEMPERATURE

Values between 2000 and 13100 K (Kelvin) can be set directly. That gives you a very wide range, which covers virtually all color temperatures occurring in real life and within which you can adapt color rendering to any light color and your personal preferences with incredible detail.

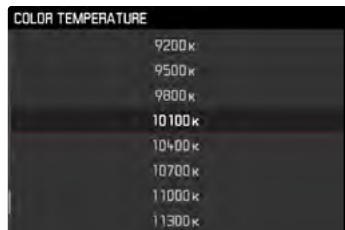

- ▶ Select **White Balance** in the main menu
- ▶ Select **Color Temperature**
- ▶ Select the desired value

EXPOSURE

The readiness of the exposure meter is signaled by continuously lit displays in the viewfinder or on the LCD panel:

- the shutter speed is displayed in aperture priority mode
- one of the two triangular LEDs lights up in the viewfinder, possibly in conjunction with the round LED in the middle, and the light balance is shown on the LCD panel for a manual setting

The exposure meter is disabled when the shutter speed setting dial is set to **B**.

EXPOSURE METERING METHODS

Optional methods are Spot metering, Center-Weighted and Multi-Field metering.

SPOT METERING –

Spot metering only captures and analyzes a small area in the center of the screen image, which is shown in a circle.

CENTER-WEIGHTED METERING –

This method considers the entire image field. The subject elements captured in the center will, however, impact on the calculation of the exposure value more so than areas around the edges.

MULTI-FIELD METERING –

This metering method is based on the detection of multiple values. These values are used in an algorithm to calculate an exposure value appropriate for a good rendering of the assumed main subject.

WHEN USING THE RANGEFINDER

Mostly center-weighted metering.

The light reflected by the light-colored shutter blades is captured and measured by a photodiode. When the measuring range of the exposure meter is undercut in a manual setting and very low light density, then the triangular LED (▶) in the viewfinder on the left will flash as a warning; the LED on the right (◀) will flash when the measuring range of the exposure meter is surpassed. The shutter speed icon will flash as a warning if a correct exposure cannot be achievable using the available shutter speeds in aperture priority mode. The relevant icon will flash if the required shutter speed would undercut the fastest possible shutter speed or overshoot the longest possible shutter speed. As exposure metering is done with the working aperture, the same can be achieved by a Stop Down of the lens.

IN LIVE VIEW MODE

Optional methods are Spot metering, Center-Weighted and Multi-Field metering. The metering will then be done via the picture sensor.

- ▶ Select **Exp. Metering** in the main menu
- ▶ Select a metering method
(**Spot**, **Center-Weighted**, **Multi-Field**)
 - The selected metering method is displayed in the header of the screen image in Live View Mode; it appears on the status screen (see p. 55) if the viewfinder is used.

Spot metering allows a shifting of the metering field:

- ▶ Tap the LCD panel at the desired position
- or
- ▶ Press the directional pad left or right as needed

EXPOSURE MODES

The camera offers two exposure modes: aperture priority mode or manual setting. Choose one of the two options depending on image object, situation or individual preference.

Notes

- Image noise becomes apparent when using higher sensitivities, particularly on uniform dark areas. In order to reduce this annoying phenomenon, the camera will take a second “black picture” (taken with the shutter closed) automatically after pictures taken with slow shutter speeds and high ISO values. The noise metered in this parallel picture is then digitally “subtracted” from the data for the actual picture. In such cases the message **Noise Reduction** will appear with a relevant time value. The doubling of the “exposure” time must be taken into account for long-term exposure times. The camera must not be switched off during that time.
- The remaining exposure time after shutter release is counted down in seconds on the display for shutter speeds greater than 2 s.

SELECTING A MODE

- ▶ Set the shutter speed setting dial **A** (Aperture priority) or select the desired shutter speed (Manual setting = **M**)



APERTURE PRIORITY - A

Aperture priority mode sets the exposure automatically according to the manually selected aperture. This mode is suitable for pictures in which the depth of field is a critical compositional element.

By selecting an appropriately low exposure value, you can reduce the depth of field range, for example to make a face “stand out” in sharp focus against an unimportant or distracting background. Conversely, you can use a higher exposure value to increase the depth of field range, so that everything from the foreground to the background will be in full focus in a landscape shot.

- ▶ Select the operating mode **A** (see p. 77)
- ▶ Set the desired exposure value
 - The automatically selected shutter speed is displayed.
- ▶ Shutter release

Notes





- The resulting shutter speed is displayed in half increments for more transparency.
- The remaining exposure time after shutter release is counted down in seconds in the viewfinder for shutter speeds greater than 2 s. The actual calculated and steplessly controlled exposure time may vary from the exposure time displayed in half step increments: if e.g. the display shows  (the closest value) before shutter release, but the calculated exposure time is longer, then the countdown after shutter release can start from .
- Under extreme lighting conditions and based on all the parameters, the exposure metering may generate a shutter speed that is outside the focus range, i.e. brightness values that would require shorter exposures than 1/4000 s or longer than 4 min. The camera will use the stated min. or max. shutter speeds and these values will flash as a warning in the viewfinder if that is the case.

MANUAL EXPOSURE SETTING – M



The following manual settings for shutter speed and aperture are a good choice:

- to create a special image mood that can only be achieved with a very specific type of exposure
- to ensure a perfectly identical exposure for multiple images with different cropped sections
- ▶ Set the desired shutter speed and aperture value
 - The shutter speed setting dial must be clicked to one of the engraved exposure shutter speeds or to one of the intermediate values.
- ▶ Shutter release

DISPLAY IN THE VIEWFINDER

	underexposure by at least one aperture stop
	underexposure by a 1/2 aperture stop
	correct exposure
	overexposure by a 1/2 aperture stop
	overexposure by at least one aperture stop

DISPLAY ON THE LCD PANEL

	correct exposure
	under/over exposure by the displayed value
	under or overexposure by more than 3 EV (Exposure Value)

LONG-TERM EXPOSURE (B)

B FUNCTION

In setting **B**, the shutter remains open as long as the shutter button is held down (up to max. 16 min depending on ISO setting).

T FUNCTION

When the **B** function is selected in conjunction with the self-timer (see p. 87), then the shutter button doesn't have to be held down. The shutter will remain open until the shutter button is pressed again (the equivalent of a **T** function). This prevents blurring in long-term exposures when the shutter button is pressed.

FIXED SHUTTER SPEEDS

This function can also be used to permanently set shutter speeds longer than 8 s.



- ▶ Set the shutter speed setting dial to **B**
- ▶ Press the focus button for approx 1 s
 - The submenu containing the shutter speeds or **B** is shown on the LCD panel. Available shutter speeds are indicated in white (may vary depending on ISO sensitivity), those not available appear in gray.
- ▶ Select the desired setting
- ▶ Tap the shutter button
 - The setting is applied and the submenu disappears.
 - The setting can alternatively be applied via any other button (except the directional pad).
- ▶ Shutter release

Notes

- In each of these cases, the exposure meter remains deactivated; after shutter release, however, the digital number display in the viewfinder counts the elapsed exposure time in seconds.
- Long exposure times may cause severe image noise. In order to reduce this annoying phenomenon, the camera will take a second “black picture” (taken with the shutter closed) automatically after pictures taken with slow shutter speeds and high ISO values. The noise metered in this parallel picture is then digitally “subtracted” from the data for the actual picture. In such cases the message **Noise Reduction** will appear with a relevant time value. The doubling of the “exposure” time must be taken into account for long-term exposure times. The camera must not be switched off during that time.

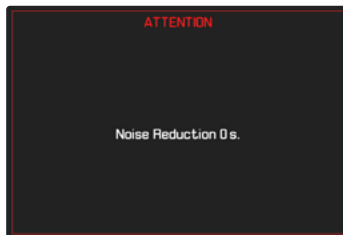

EXPOSURE CONTROL

EXPOSURE PREVIEW

You can now assess the effect of the relevant exposure setting on the image before taking the picture.

There are two assessment methods available.

- **Release button half pressed**
The brightness of the screen image mirrors the effects of the selected exposure settings when pressing and holding the shutter button on the first pressure point. This is displayed as . At all other times, the display in Live View shows an optimal exposure setting.
 - **Permanent**
The brightness of the screen image matches the exposure setting. This is displayed as .
- ▶ Select **Capture Assistants** in the main menu
 - ▶ Select **Exposure Simulation**
 - ▶ Select the desired setting

Note

- Depending on ambient lighting conditions, the brightness of the screen image may differ from that of the actual pictures, despite the settings described above.

METERING MEMORY LOCK

We often want to arrange important subject elements outside the center of the picture for reasons of picture composition and these elements may sometimes be very bright or very dark. Center-weighted metering and spot metering, however, mainly capture an area in the center of the image and are calibrated to an average gray scale value. In that case the metering memory lock initially allows a metering of the main object and to store the relevant settings until the final image section is set.

- ▶ Aim at the important image component (using the metering field for spot metering) or alternatively at another detail with average brightness.
- ▶ Tap the shutter button
 - The measurement is taken and saved.
 - As long as the shutter button is held at the first pressure point, a small red dot will appear in the viewfinder at the top in the number line for confirmation, and the exposure time won't change, even if lighting conditions change.
 - Pan the camera to capture the final image section while keeping the shutter button pressed.
- ▶ Shutter release

Notes

- A metering memory lock doesn't make much sense in conjunction with multi-field metering, because a targeted capture of an individual object element will not be possible.
- A change in the aperture setting after the metering memory lock is set will not result in an adjustment of the shutter speed, i.e. the end result would be an incorrect exposure.

EXPOSURE COMPENSATION

Exposure meters are calibrated for a medium gray scale value, which matches a standard, i.e. average image object. Should the measured image detail not fulfill that requirement, then the a relevant exposure compensation can be effected.

Specifically where several pictures are taken in sequence, for example if for a series a slightly lesser or greater exposure is desired for a particular reason, then exposure compensation can be a very useful function: Once set, the setting remains active – unlike the metering memory lock – until it is reset.

Exposure compensation can be set in the range ± 3 EV in $1/3$ EV increments (EV: exposure value).

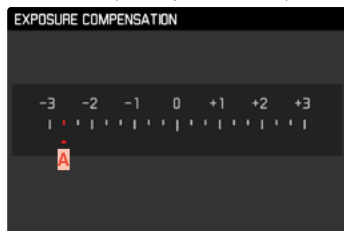

A Set compensation value (marks at 0 = Off)

Using thumbwheel control

- ▶ Select **Customize Control** in the main menu
- ▶ Select **Customize Wheel**
- ▶ Select **Exposure Compensation**

- ▶ Set the desired value using the thumbwheel

Using menu control

- ▶ Select **Exposure Compensation** in the main menu
 - A scale appears as a submenu item on the LCD panel.
- ▶ Set the value on the scale

Notes

- The following applies for set compensation values, no matter how they were initially set: They remain effective until they are manually reset to **0**, i.e. even if the camera is switched off and on again in the meantime. They can be reset using either menu control or the thumbwheel.
- In case of **A**, the compensation value is displayed in the viewfinder, for example **1.0** (temporary display instead of the shutter speed). It will then be displayed as changed shutter speeds and a flashing dot at the bottom or as a value for about 0.5 s, when the display is activated.
- The set exposure compensation is indicated by a mark on the exposure compensation scale in the footer line.

PICTURE RECORDING MODES

SERIAL EXPOSURES

The camera is set to single shot exposures (**Single**) by default. Serial exposures can also be created to e.g. capture motion sequences at various stages.

- ▶ Select **Drive Mode** in the main menu
- ▶ Select the desired setting
(**Continuous Low Speed**, **Continuous High Speed**)

Once you have finalized your settings, the camera will take serial exposures as long as you keep the shutter button pressed down fully (and you have sufficient space on your memory card).

Notes

- We recommend deactivating the preview mode (**Auto Review**) when using this function.
- The specified picture sequence stated in the technical information refers to a default setting (**ISO 200**, JPG format **L-JPG**). Frequency and number may vary depending on the settings, the image content, the **White Balance** setting and the memory card used.
- Regardless of how many pictures were taken in a series, the last picture in the series or the last picture saved on the memory card while the save process is ongoing will be displayed first in both review modes.
- Serial exposures with **Continuous High Speed** set are taken at a frequency of max. 4.5 fps, provided shutter speeds of 1/60 s or faster are used.
- Serial exposures are not possible if a flash is used. Only a single picture will be taken if the flash function is activated.
- Serial exposures are not available in combination with the self-timer function.
- The buffer memory of the camera only allows a limited number of exposures in series and in the selected exposure frequency. The exposure frequency is reduced, once the capacity limit of the camera's buffer memory is reached.

INTERVAL SHOOTING

This camera allows you to capture motion sequences over extended periods of time automatically using the interval shooting function. You must specify the interval between shots and the number of frames in the series.

The exposure and focus settings are no different from those for normal pictures, but you should remember that the lighting conditions may change during the course of the picture series.

SPECIFYING THE NUMBER OF FRAMES

- ▶ Select **Drive Mode** in the main menu
- ▶ Select **Interval**
- ▶ Select **Frames**
- ▶ Enter the desired value

SPECIFYING THE INTERVALS BETWEEN SHOTS

- ▶ Select **Drive Mode** in the main menu
- ▶ Select **Interval**
- ▶ Select **Interval Time**
- ▶ Enter the desired value

To get started

- ▶ Press the shutter button
 - The remaining time until the next exposure and the number of pictures taken are displayed at the top right of the image.

To cancel a running serial exposure

- ▶ Press the **MENU** button

Notes

- Interval shooting over an extended period of time in a cold location or in a place with high temperature and humidity may result in malfunctions.
- Interval shooting will be interrupted or canceled in the following situations:
 - if the battery is depleted
 - if the camera is switched off

Make sure to check the battery for sufficient charge. A warning will be displayed when the battery reaches a critically low level.

- The interval function remains active after a picture series is completed, and also after the camera is switched off and on again, until another exposure mode (Drive Mode) is set.
- Availability of the interval function does not mean that the camera is suitable for use as a monitoring device.
- Regardless of how many pictures were taken in a series, the last picture in the series or the last picture in the series or the last picture saved on the memory card while the saving process is ongoing will be displayed first in both review modes.
- We recommend deactivating Live View mode for longer interval shoots or picture series.

EXPOSURE BRACKETING

Many attractive objects are rich in contrast, which means they have very bright and very dark areas. The image effect can be dramatically different, depending on which of these areas you choose to align your exposure with. The automatic bracketing function in aperture priority mode allows you to produce several alternatives with graduated exposure values and varying shutter speeds. You can then select the picture you like best or use relevant picture editing software to calculate an image with a particularly broad contrast spectrum (HDR).

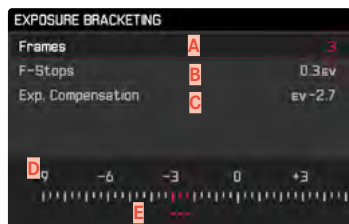

- A** Number of frames
- B** Exposure difference between the pictures
- C** Exposure Compensation
- D** Light value scale
- E** Exposure values of the images marked in red
(The scale will be offset by the relevant value if exposure compensation is set concurrently.)

You can select the desired number of frames (3 or 5). The exposure difference, which can be set via **F-Stops**, can be up to 3 EV.

- ▶ Select **Drive Mode** in the main menu
- ▶ Select **Exposure Bracketing**
- ▶ Select the desired number of pictures in the submenu under **Frames**
- ▶ Select the desired exposure offset in the submenu under **F-Stops**
- ▶ Select the desired **Exposure Compensation** value in the submenu
 - The marked exposure values change positions according to the settings selected. In the case of exposure compensation, the scale also shifts.
 - The selected exposure compensation value will be applied to the entire exposure series.
- ▶ Shutter release

Notes

-  Appears on the LCD panel if the bracketing function is activated.
- The picture sequence: underexposure/correct exposure/overexposure.
- The working range for automatic bracketing may be limited depending on the available shutter speed/aperture combination.
- With automatic ISO sensitivity control enabled, the sensitivity calculated by the camera automatically for the raw picture will also be applied to all other pictures in a series, i.e. the ISO value will not change during bracketing. This may mean that the slowest shutter speed specified under **Maximum Exposure Time** is exceeded.
- The focus range for automatic bracketing may be limited (depending on the originally set shutter speed). The specified numbers of pictures will be taken regardless. Several pictures in a series may consequently be taken with the same exposure values.
- The function remains active until another function is selected in the **Drive Mode** submenu. If no other function is selected, another series of pictures is taken each time the shutter button is pressed.

SELF-TIMER

The self-timer function allows taking pictures with a preset time delay. We recommend that the camera is placed on a tripod.

- ▶ Select **Drive Mode** in the main menu
- ▶ Select **Self Timer 2 s**/**Self Timer 12 s**
- ▶ Shutter release
 - The remaining time until exposure is counted down on the LCD panel. The self-timer LED at the front of the camera counts down the delay time.
 - A running self-timer delay time can be canceled at any time by pressing the **MENU** button and restarted by pressing the shutter button.

Notes

- In self-timer mode, the exposure value is set just before the picture is taken.
- The function remains active until another function is selected in the **Drive Mode** submenu.

INFO DISPLAYS

INFO DISPLAYS IN PICTURE MODE

In Live View mode, the LCD panel can be used for displaying a range of settings. Various information is displayed in the header and/or footer line.

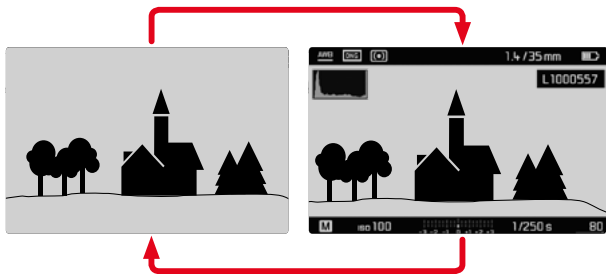

- ▶ Press the center button
 - The display toggles between a visualization with or without information displays.

Showing/hiding information temporarily

Depending on the initial situation, the display toggles to the other setting when the shutter button is held at the first pressure point.

- ▶ Tap and hold the shutter button

Initial situation	Temporary display
Visualization with displays (Header and footer line)	Header and footer line are hidden
Visualization without displays	The footer line is displayed (Exposure information)

You can select a number of other displays in addition to the standard information contained in the header and footer to adapt the screen image to your needs.

The following assist functions can be displayed or hidden via the info displays:

- Clipping (see p. 89)
- Level Gauge (see p. 90)
- Histogram (see p. 91)

AUXILIARY DISPLAYS

CLIPPING

The Clipping display marks bright or dark areas in the image lacking definition (bright areas flash in red; dark areas flash in blue). To adjust these displays to specific conditions or your compositional ideas, you can specify limit values, i.e. the level of over/underexposure at which they appear. The Clipping display therefore offers a very simple and exact means for checking and adjusting your exposure settings.

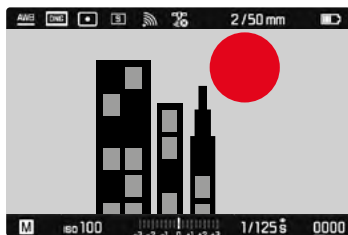

- ▶ Select **Capture Assistants** in the main menu
 - ▶ Select **Exposure Clipping**
 - ▶ Select **Clipping Enabled**
 - ▶ Select **On/Off**
 - The two other lines are not selectable (= gray) when the function is deactivated.
-
- ▶ Activate information displays (see p. 88)
 - ▶ Tap and hold the shutter button
 - The clipping display appears.

SETTING LIMIT VALUES

You can set a threshold value for these displays, i.e. define a value at what degree of overexposure they will appear, so that you can adjust these displays to specific conditions or in line with your own composition ideas.

- ▶ Select **Capture Assistants** in the main menu
- ▶ Select **Exposure Clipping**



- ▶ Select **Lower Limit**
- ▶ Select the desired value (0 to 20)
- ▶ Select **Upper Limit**
- ▶ Select the desired value (200 to 255)

Note

- The clipping display always refers to the currently displayed cropped section.

LEVEL GAUGE

The integrated sensors of the camera show its orientation. These indicators ensure exact camera orientation along the longitudinal and transverse axes of critical objects, e.g. architecture.

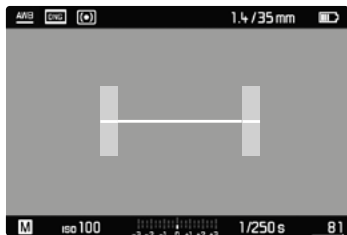

- ▶ Select **Capture Assistants** in the main menu
- ▶ Select **Level Gauge**
- ▶ Select **On/Off**

- ▶ Activate information displays (see p. 88)

In the screen image, the horizon is denoted by a long line across the center of the image on its transverse axis.

- in zero position = green
- in tilted position = red

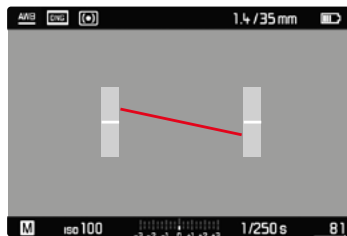

The longitudinal axis is indicated in zero position by two short lines in the gray bars to the left and right of the image center.

- in zero position = green
- in tilted position = red

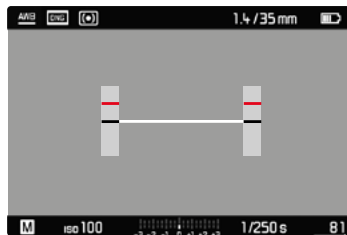

Note

- The camera will switch the aspect of the level gauge autonomously for pictures taken in portrait format.

GRID

The grids divide the image frame into multiple fields. They facilitate picture composition and an exact camera orientation. The grid line distribution can be adjusted to fit the object.

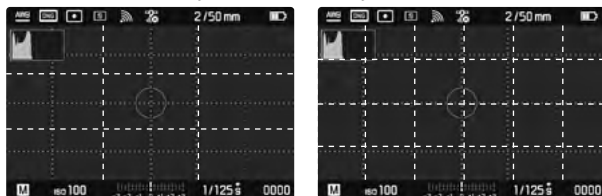

You can choose one of two grid displays. They divide the frame into 3 x 3 or 6 x 4 fields.

- ▶ Select **Capture Assistants** in the main menu
- ▶ Select **Grids**
- ▶ Select the desired setting
(**Off**, **3x3 Fields**, **6x4 Fields**)

HISTOGRAM

Histogram represents the brightness distribution in the picture. The horizontal axis shows the graduated values from black (left) through gray to white (right). The vertical axis corresponds to the number of pixels at each brightness level.

This type of rendering allows an additional quick and easy assessment of the exposure setting.



- ▶ Select **Capture Assistants** in the main menu
- ▶ Select **Histogram**
- ▶ Select **On/Off**

- ▶ Activate information displays (see p. 88)

The settings made for exposure preview (**Exposure Simulation**) dictate when the histogram will be displayed. For settings see p. 81.

Setting for Exposure Simulation	Display of the histogram
Release button half pressed	While pressing and holding the shutter button on the first pressure point.
Permanent	Permanent

Notes

- The histogram is always based on the brightness displayed; depending on the settings used, it may not represent the final exposure.
- In picture mode, the histogram should be regarded as a "trend indicator".
- The histogram during rendering may differ slightly from the one during exposure.
- Histogram is available only in full screen mode.

FLASH PHOTOGRAPHY

The camera determines the necessary flash intensity by firing one or more pre-flashes before taking the actual picture. The main flash fires immediately after, i.e. during exposure. All factors influencing exposure (e.g. filters, aperture settings, distance to the main subject, reflective ceilings, etc.) are automatically considered.

COMPATIBLE FLASH UNITS

The entire scope of functions described in this instruction manual, incl. TTL flash metering, is available only for Leica system flash units like the SF 40. Other flash units, which only have a positive center contact, can be safely fired via the Leica M10-R, but cannot be controlled via the camera. Correct function cannot be guaranteed when using any other flash unit.

Note

- When using flash units that are not specifically designed for the camera and can therefore not automatically switch over the white balance of the camera should be used in the **WB** flash setting.

Important

- The use of incompatible flash units with your Leica M10-R may result in irreparable damage to the camera and/or the flash unit.

ATTACHING THE FLASH UNIT

- ▶ Switch off the camera and flash unit
- ▶ Slide the foot of the flash unit all the way into the accessory shoe and use the clamping nut (where available) to secure it against accidental movement
 - Movement inside the accessory shoe can interrupt required contacts and therefore cause malfunctions.

DETACHING THE FLASH UNIT

- ▶ Switch off the camera and flash unit
- ▶ Detaching the flash unit

Note

- Make sure that the accessory shoe cover is always in place when no accessory is attached (e.g. a flash unit).

FLASH EXPOSURE METERING (TTL METERING)

In conjunction with system-compatible flash units (see p. 92), the camera offers a fully automated flash mode, which is also available in the auto modes aperture priority and manual setting.

In aperture priority mode and with manual setting, the camera furthermore allows the use of other interesting flash techniques like flash synchronization and firing with slower shutter speeds than the max. sync time.

The camera additionally communicates the sensitivity setting to the flash unit. The flash unit can use this information to automatically adjust its range data, provided the device comes with these displays and the aperture setting selected on the lens is also entered manually on the flash unit. The ISO sensitivity setting cannot be altered via the flash unit on system-compatible units, because the information is received from the camera.

SETTINGS ON THE FLASH UNIT

Operating mode	
TTL	Automatic camera control
A	SF 40, SF 60: Automatic camera control, no flash exposure compensation SF 58, SF 64: Control via the flash unit using a built-in exposure sensor
M	The flash exposure must be set to an output level to match the aperture and shutter speed settings determined by the camera.

Notes

- Set the flash unit to **TTL** mode to allow automatic control of the unit by the camera.
- When set to **A**, objects with above or below average brightness may not be exposed correctly.
- Please read the relevant manual provided with third party flash units regarding their various operating modes.

HSS (HIGH SPEED SYNC.)

Automatic flash activation at **fast** shutter speeds

A fully automated, camera-controlled HSS flash mode for all shutter speeds and all exposure modes is available in the Leica M10-R for use with system-compatible flash units (see p. 92). It is activated by the camera automatically if the selected or calculated shutter speed is faster than the sync speed (1/180 s).

Note

- The range for HSS flashes is significantly lower than for TTL flashes.

FLASH CONTROL

The settings and functions described in the following sections only apply to settings and functions available in this camera and in system-compatible flash units.

SYNC POINT

Flash exposures are lit by two light sources:

- ambient light
- flash

Any subject elements lit primarily by the flash will almost always be rendered in perfect focus by the short burst of light, provided the focus is set correctly. All other subject elements in the same frame lit by ambient light or lit from within will be rendered with varying degrees of sharpness. Whether or not these subject elements will be rendered in sharp focus or blurred, as well as the degree of "blurriness" depends on two interdependent factors:

- the shutter speeds
- the speed of movement of the subject elements or camera during recording

The longer the shutter speed and the faster the motion, the greater the difference between the two superimposed partial images.

A flash is usually fired at the start of exposure (**Start of Exp.**), right after the first shutter curtain has completely opened the image window. This may result in apparent contradictions, e.g. the picture of a vehicle being overtaken by its own light trail. Alternatively, this camera allows a synchronization of the flash firing at the end of exposure (**End of Exposure**), right before the second shutter curtain closes the image window. The sharp image will in this case be a rendering of the end of the captured motion. This flash technique creates a more natural impression of movement and dynamics in the image.

This function is available with all camera and flash unit settings.

Factory setting: **Start of Exp.**

- ▶ Select **Flash Settings** in the main menu
- ▶ Select **Flash Sync. Mode**
- ▶ Select the desired setting
(**Start of Exp.**, **End of Exp.**)

Notes

- Do not use synch cables that are longer than 3 m/10 feet.
- When using the flash with faster shutter speeds, a difference between the two flash firing points will be barely discernible or only noticeable for very fast movements.

FLASH RANGE

The usable flash range depends on the aperture and sensitivity values set manually or calculated by the camera. It is important to ensure that the subject is within the relevant flash range for sufficient illumination. A permanent setting to the shortest available shutter speed for flash mode (sync time) may often result in unnecessary underexposure of those subject elements that are not lit sufficiently by the flash.

This camera allows the fine tuning of the shutter speed used in flash mode in combination with aperture priority depending on the conditions of the object or your own picture composition ideas.

Factory setting: **1/1**

- ▶ Select **Flash Settings** in the main menu
- ▶ Select **Max. Flash Sync. Time**
- ▶ Select the desired value

(1/1, 1/(2f), 1/(4f), 1/125 s, 1/60 s, 1/30 s, 1/15 s, 1/8 s, 1/4 s, 1/2 s)

FLASH EXPOSURE COMPENSATION

This function can be used to selectively reduce or enhance flash exposure regardless of ambient light, e.g. to brighten the face of a person in the foreground when taking a picture outdoors in the evening while retaining the same general lighting mood.

Factory setting: **0 EV**

- ▶ Select **Flash Settings** in the main menu
- ▶ Select **Flash Exposure Compensation**
 - A scale with a red setting mark is displayed in the submenu. The function is deactivated if the value is set to **0**.
- ▶ Set the value on the scale

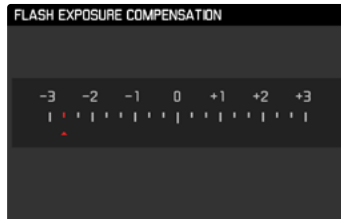

Notes

- The following applies for set compensation values, no matter how they were initially set: They remain effective until they are manually reset to 0, i.e. even if the camera is switched off and on again in the meantime.
- **Flash Exposure Compensation** is not available if flash units with an integrated compensation function are used, e.g. Leica SF 58.
- A compensation value configured on the camera will be overruled when a relevantly equipped flash unit is attached, e.g. a Leica SF 60 and a compensation value is entered on that flash unit.
- The menu item **Flash Exposure Compensation** can only be used in conjunction with flash units on which the correction value cannot be set manually (e.g. Leica SF 26).
- A brighter flash illumination with Plus compensation will require a greater flash intensity. Flash exposure compensation will therefore impact on the flash range: A Plus correction will decrease it, a Minus correction will increase it.
- An exposure compensation set on the camera will only affect the measurement of ambient light. If a simultaneous TTL flash exposure metering compensation is desired in flash mode, then it must be additionally set on the flash unit. (Exception: On the Leica SF 26, the compensation value must be set on the camera via menu control.)

FLASH PHOTOGRAPHY

- ▶ Switch on the flash unit
- ▶ Set the desired guide number control mode (e.g. TTL or GNC = Guide Number Control) on the flash unit
- ▶ Switching the camera on
- ▶ Set the desired exposure mode, shutter speed and/or aperture setting
 - It is imperative to take note of the shortest flash sync speed, as it determines whether a "normal" flash or an HSS flash is fired.
- ▶ Tap the shutter button before each flash exposure to activate exposure metering
 - The flash unit may not fire if this step is missed by pressing the shutter button down completely and skipping these settings.

Notes

- A flash unit that is not ready to flash may cause incorrect exposures or error messages in the camera.
- Studio flash systems may have a very long flash firing duration. It may therefore be advantageous to select a slower shutter speed than 1/180 s when using such a system. The same applies for RF-controlled flash firing for so-called "off-camera" flashes, as the transmission time may cause a delay.
- Serial exposures and automatic bracketing with flash are not available.
- Use a tripod to prevent blurring at slow shutter speeds. Alternatively, you can select a higher sensitivity.

FLASH EXPOSURE DISPLAYS IN THE VIEWFINDER (with system-compatible flash units)

The flash icon in the viewfinder display of the Leica M10-R gives feedback on and indicates various operating states.

<p>⚡ does not appear (despite the flash unit being switched on and ready)</p>	<ul style="list-style-type: none"> • The flash unit cannot fire • A correct operating mode must be set on the flash unit or an HSS-compatible flash unit must be connected
<p>⚡ <u>flashes</u> slowly before the picture is taken (2 Hz)</p>	<ul style="list-style-type: none"> • The flash unit is not yet ready for use
<p>⚡ <u>lights up</u> before the picture is taken</p>	<ul style="list-style-type: none"> • The flash unit is ready for use
<p>⚡ <u>remains</u> continuously lit after shutter release*</p>	<ul style="list-style-type: none"> • The flash is still ready
<p>⚡ <u>flashes</u> rapidly after shutter release (4 Hz)*</p>	<ul style="list-style-type: none"> • Successful flash photography • The flash unit is not yet ready for further use
<p>⚡ switches off after shutter release*</p>	<ul style="list-style-type: none"> • Flash intensity was insufficient

*only in TTL flash mode

REVIEW MODE

There are two completely independent review functions available:

- short-term rendering directly after exposure (Preview)
- normal Review mode, in which the stored recordings can be viewed and managed for any length of time

Notes

- Recorded pictures are not automatically rotated in Review mode to utilize the full screen area.
- It may not be possible to render files with this camera that were not recorded with this device.
- In some cases, the screen image may not have the expected quality, or the LCD panel will remain blank and only display the file name.
- You can toggle back from review mode to recording mode at any time by tapping the shutter button.

CONTROL ELEMENTS IN REVIEW MODE



18 LV button

19 PLAY button

20 MENU button

16 Thumbwheel

23 Directional pad

24 Center button

INITIATE/EXIT REVIEW MODE

- ▶ Press the **PLAY** button
 - The last picture taken appears on the LCD panel.
 - The message **No media file to display** appears if the inserted memory card does not contain any picture data.
 - The **PLAY** button function differs, depending on the current camera setting:

Initial situation	After pressing the PLAY button
Full screen rendering of a recording	Picture mode
Rendering of an enlarged cropped section/or several thumbnails	Full screen review of the recording

SELECTING/SCROLLING THROUGH RECORDINGS

The recordings are visually arranged in a horizontal reel. When the end of an image series is reached, the display automatically jumps back to the first image in the series. All recordings can therefore be reached by scrolling either right or left.

Using touch control

- ▶ Swipe to the left or right

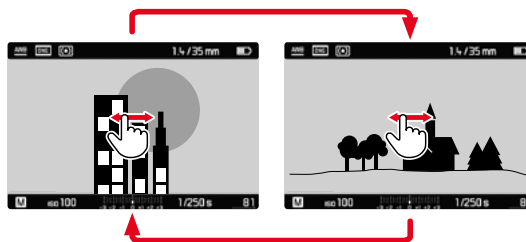

Using button control

- ▶ Press the directional pad left/right

INFO DISPLAYS IN REVIEW MODE

With the factory settings in place, recorded pictures will be displayed without the information in the header and footer lines for an unobstructed view of the image.



The configured displays can be accessed at any time. The displays for **Histogram** and **Clipping** will appear if these functions are activated.

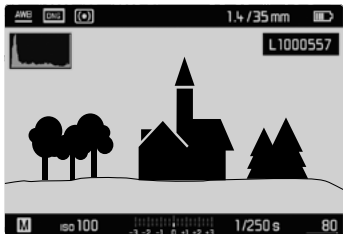

Using touch control

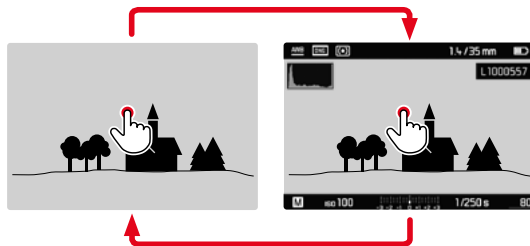

- ▶ Briefly tap the LCD panel

Using button control

- ▶ Press the center button

Note

- The histogram and clipping displays always refer to the currently shown picture section.

CROPPED SECTION ZOOM

You can zoom in to any section of an image for closer inspection. You have a four-level zoom factor available via the thumbwheel, while magnification is stepless if you use touch control.

Using touch control

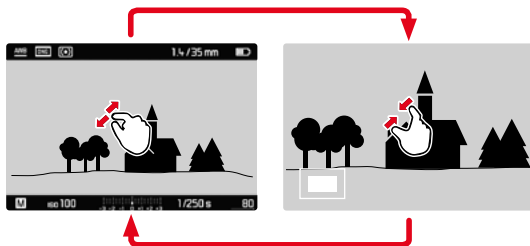

- ▶ Two-finger pinch/spread
 - The recording will be zoomed in/zoomed out at the desired point.



- ▶ Swiping will allow you to move the position of an enlarged cropped section
 - The rectangle within the frame in the bottom left corner represents the current magnification, as well as its position in the image.

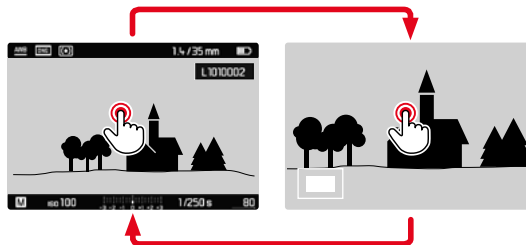

- ▶ Double tap
 - Toggles between max. magnification at the tap position and full screen view.

Using button control

- ▶ Turn the thumbwheel
(to the right: increase magnification, to the left: decrease magnification)
- ▶ Press the directional pad to move the cropped section anywhere in the enlarged image
 - The rectangle within the frame in the bottom left corner represents the current magnification, as well as its position in the image.

You can move directly from one picture to the next in magnification mode, which will then also be displayed with the same magnification.

- ▶ Press and hold the **PLAY** button while pressing the directional pad left/right

or

- ▶ Press and hold the **PLAY** button while turning the thumbwheel

Note

- It may not be possible to enlarge pictures taken with other camera types.

DISPLAYING MULTIPLE RECORDINGS AT ONCE

The camera offers an overview function in which several thumbnail images can be viewed on one screen, which makes it easier to find a specific image. You can choose 12 or 20 images per overview.

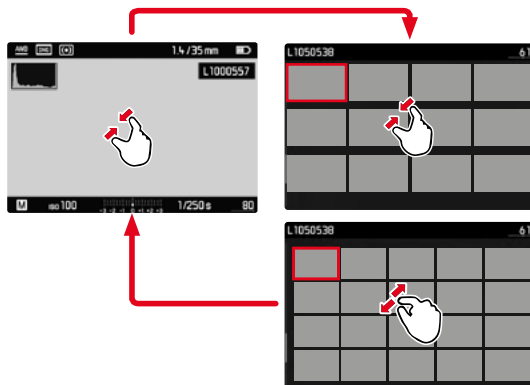
OVERVIEWUsing touch control

- ▶ Two-finger pinch
 - The display toggles from 12 to 20 thumbnails.

To view other recordings

- ▶ Swipe up or down

Using button control

- ▶ Turn the thumbwheel to the left
 - 12 thumbnails are shown at the same time. Another turn on the thumbwheel increases the number of pictures to 20.

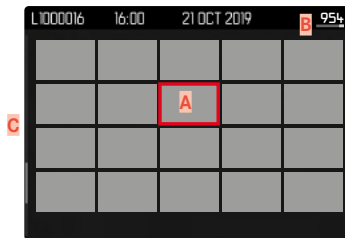

- A** Currently selected recording
- B** Number of the currently selected recording
- C** Scrollbar

The currently viewed recording is framed in red and can be selected for a closer look.

Navigating between recordings

- ▶ Press the directional pad left or right as needed

DISPLAYING RECORDINGS IN BLOCKS OF 20

In this view, you can browse through the blocks easily.

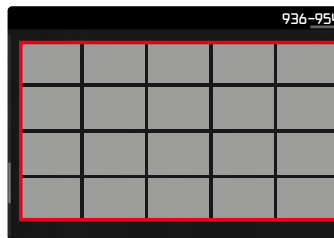

- ▶ Reduce the size of the images until the entire field is framed in red
 - ▶ Press the directional pad left or right as needed
- or
- ▶ Swipe up or down

RETURNING TO FULL SCREEN VIEW

Using touch control

- ▶ Two-finger spread

or

- ▶ Briefly touch the image

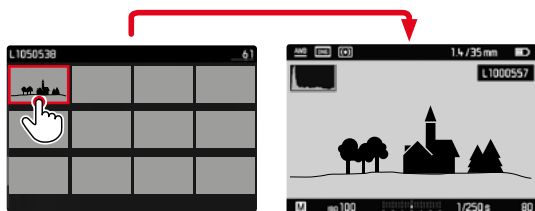

Using button control

- ▶ Turn the thumbwheel to the right

or

- ▶ Press the **PLAY** button/the center button

TAGGING/RATING OF RECORDINGS

Recordings can be tagged as favorites to find them quicker or to simplify the later deletion of multiple recordings.

Notes

- Other recordings can be selected while the review menu is active.
- You can exit the review menu at any time by pressing the **MENU** button.

TAGGING RECORDINGS

- ▶ Press the directional pad up
 - The recording is tagged with ★.

or

- ▶ Press the **MENU** button
- ▶ Select **Rate**
 - The recording is tagged with ★.



REMOVING INDIVIDUAL TAGS

- ▶ Press the directional pad down
 - The ★ tag disappears.

or

- ▶ Press the **MENU** button



- ▶ Select **Unrate**

REMOVING ALL TAGS

- ▶ Press the **MENU** button



- ▶ Select **Unrate ALL**
 - The LED will flash during this operation.

DELETING RECORDINGS

There are several methods available to delete recordings:

- deleting individual recordings
- deleting all recordings without a tag/ranking
- deleting all recordings



Important

- Once deleted, recordings are no longer retrievable.

Notes

- Other recordings can be selected while the review menu is active.
- You can exit the review menu at any time by pressing the **MENU** button.

DELETING INDIVIDUAL RECORDINGS

- ▶ Press the **MENU** button



- ▶ Select **Delete Single** in the Review menu
 - The Delete screen appears.



- ▶ Press the center button
 - The LED will flash during the delete process. The process may take a few seconds.
 - The next recording will be displayed once deletion is complete. The message **No media file to display** appears if no other recordings are saved on the card.

To cancel deletion and return to the normal review mode

- ▶ Press the **PLAY** button

Note

- The “Scroll” and “Magnify” functions continue to be available when the “Delete” screen is active.

DELETING ALL RECORDINGS

- ▶ Press the **MENU** button



- ▶ Select **Delete Multi** in the Review menu



- ▶ Select **ALL**

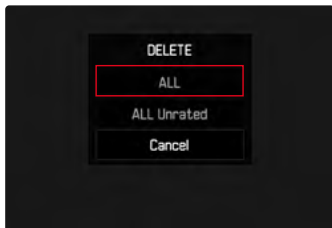

- The prompt **Really delete all?** appears.

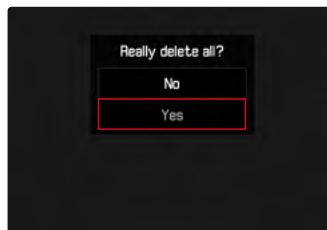

- ▶ Select **Yes**

Note

- The LED will flash during the delete process. The process may take a few seconds. The message **No media file to display** appears after successful deletion.

DELETING UNRATED RECORDINGS

- ▶ Press the **MENU** button



- ▶ Select **Delete Multi** in the Review menu



- ▶ Select **ALL Unrated**

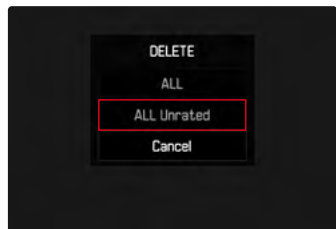

- The prompt **Really delete all unrated?** appears.



- ▶ Select **Yes**
 - The LED will flash during the delete process. The process may take a few seconds.
 - The next marked recording appears once deletion is complete. The message **No media file to display** appears if no other recordings are saved on the card.

PREVIEW OF LATEST RECORDING

Recordings can be displayed automatically directly after they are taken to e.g. check the success of the recording quickly and easily. A duration for the automatic display can be configured.

- ▶ Select **Auto Review** in the main menu
- ▶ Select the desired function or duration in the submenu
(Off, 1 s, 3 s, 5 s, Permanent)

Permanent: The most recent recording is displayed until automatic review is ended by tapping the shutter button.

Notes

- Various control elements change back to regular review mode to execute their normal functions while automatic preview is selected. The camera will remain in Review mode until it is exited.
- Tagging and deleting can only be done in regular Review mode and not during automatic review.
- When pictures were taken with the functions Serial exposures or Interval shooting, then the last image in the series will be displayed or – if the save process is still incomplete – the last image in the series saved to the memory card.
- Where display times were configured (1 s, 3 s, 5 s) automatic review can be ended immediately by tapping the shutter button.

OTHER FUNCTIONS

USER PROFILES

This camera allows the permanent storage of any menu settings, to e.g. access them quickly and easily for recurring conditions/image objects. Six memory slots are provided to store custom settings, plus the factory setting, which is always available and cannot be modified (**Standard Profile**). You can assign names for the saved profiles yourself.

Any profiles configured for the camera can be saved to a memory card for use on another camera. Similarly, profiles saved on a memory card can be transferred to the camera.

SAVING CURRENT SETTINGS AS A USER PROFILE

CREATING PROFILES

Saving settings/Creating a profile

- ▶ Create custom settings for the desired functions via menu control
- ▶ Select **User Profiles** in the main menu
- ▶ Select **Save as User Profile**
- ▶ Select a memory slot
- ▶ Confirm the selection

Notes

- Existing profiles are overwritten with the latest settings.
- A memory slot can only be deleted via the function **Reset Camera** described in the section "Resetting the camera to factory settings" (see p. 118).

RENAMING PROFILES

- ▶ Select **User Profiles** in the main menu
- ▶ Select **Rename User Profile**
- ▶ Select a profile
- ▶ Enter a name for the profile via the associated submenu keyboard and confirm your input (see p. 51)
 - Profile names must be between 3 and 5 characters in length.

APPLY/ACTIVATE PROFILES

Factory setting: `Standard Profile`

- ▶ Select `User Profiles` in the main menu
- ▶ Select `Load Profile`
 - A list of profile names is displayed.
- ▶ Select a profile
 - The selected profile is marked as `active`.

Note

-  will appear in the original menu list instead of the name of the profile used if you change one of the settings for the profile currently in use.

EXPORTING/IMPORTING PROFILES TO/FROM THE MEMORY CARD

- ▶ Select `User Profiles` in the main menu
- ▶ Select `Export to Card` or `Import from Card` in the submenu
- ▶ Confirm the selection

Notes

- When importing and exporting, all profile slots are transferred to the card, i.e. including any empty slots. Any existing profiles stored in the camera will be overwritten, during the profile import. Individual profiles cannot be imported or exported.
- Any existing set of profiles will be replaced on the memory card during an export without an acknowledgment prompt.

DATA MANAGEMENT

DATA STRUCTURE ON THE MEMORY CARD

FOLDER STRUCTURE

The files (= pictures) on the memory cards are saved in automatically generated folders. The first three characters signify the folder number (numerals), the last five the folder name (letters). The first folder is assigned the name "100LEICA", the second "101LEICA". A folder will always be created with the next available number; you can have max. 999 folders.

FILE STRUCTURE

The file names in these folders consist of eleven characters. In the factory settings, the first file is named "L1000001.XXX", the second "L1000002.XXX", etc. The first letter can be selected, the "L" from the factory settings denotes the camera brand. The first three characters signify the folder number (numerals). The next four digits denote the sequential file number. Once file number 9999 is reached, then a new folder will be automatically created, in which the file numbering begins at 0001 again. The last three places after the dot denote the file format (DNG or JPG).

Notes

- When using memory cards that were not formatted with this camera, the file numbering will begin with 0001 again. Should the memory card already contain a file with a higher number, then numbering will be continued from that number.
- A relevant message will be displayed on the LCD panel once folder number 999 and file number 9999 are reached, and all numbering must be reset.
- Format the memory card and reset the picture number right after to reset the folder number to 100.

EDIT FILE NAMES

- ▶ Select **Image Numbering** in the main menu
- ▶ Select **Change Filename**
 - A keyboard submenu is displayed.
 - The input line contains the full file name. The four characters marked in white in the first group can be modified.
- ▶ Delete the four selected characters
- ▶ Enter a new name of your choice (see p. 51)
- ▶ Confirm

Notes

- The change to a file name applies for all later pictures as well until a new change is made. The sequential number (second 4-digit group of numerals) will not be affected by the change; it can, however, be reset by creating a new folder.
- Lower case letters are unavailable.

CREATING A NEW FOLDER

- ▶ Select **Image Numbering** in the main menu
- ▶ Select **New Folder**
 - A keyboard submenu is displayed.
 - The input line contains the full folder name. The five white characters can be modified.
- ▶ Delete the five selected characters
- ▶ Enter a name of your choice
- ▶ Confirm
 - A prompt appears. Here you decide if you want the file numbers in the new folder to start at 0001 again (**Yes**) or if the numbering should continue (**No**).

Notes

- A file name change also applies to all subsequent folders or until another change is made.
- When all user-affected changes are reset, then the folder name will once again be “XXXLEICA”.
- Lower case letters are unavailable.

RESETTING IMAGE NUMBERING

- ▶ Select **Image Numbering** in the main menu
- ▶ Select **Reset Image Numbering**
 - A relevant prompt is displayed.
- ▶ Select **Yes/No**

Note

- The name part of a new folder created using **Reset Image Numbering** remains unchanged. The file numbers in the folder will start again at 0001.

ADDING COPYRIGHT INFORMATION

This camera allows you to enter letters and other characters as a copyright mark for your picture files.



You can enter up to 20 characters of information under 2 headings per picture.

- ▶ Select **Camera Information** in the main menu
- ▶ Select **Copyright Information**
- ▶ Activate the **Copyright** function (**On**)
- ▶ Select **Information/Artist** in the submenu
 - A keyboard submenu is displayed.
- ▶ Enter the desired information (see p. 51)
- ▶ Confirm

RECORDING THE IMAGE LOCATION WITH GPS (ONLY IN CONJUNCTION WITH LEICA VISOFLEX)

The GPS (global positioning system) allows the pinpointing of a receiver anywhere in the world. This function is available only with Leica Visoflex attached. The camera will then continuously receive the current GPS data (latitude and longitude, elevation above sea level) and writes this information into the Exif data of the images.

Please read "Important notes regarding the use of GPS" (see p. 4) before using this function.

- ▶ Select **GPS** in the main menu
- ▶ Select **On/Off**
 - The "satellite" icon on the LCD panel indicates the current status:
 -  most recent geolocation max. 6 min. ago
 -  most recent geolocation max. 24 h ago
 -  no geolocation data available

FORMATTING A MEMORY CARD

Memory cards that have already been in use with this camera will usually not require formatting. An unformatted memory card that is inserted into the camera for the first time must be formatted. We recommend formatting memory cards from time to time, because residual data traces (data pertaining to individual pictures) may reduce the card's memory capacity.

- ▶ Select **Format SD** in the main menu
- ▶ Confirm the selection

Notes

- Never switch off the camera while data transfer is in progress.
- All data stored on a memory card will be lost during formatting. Formatting will not be prevented by the deletion protection set for individual pictures.
- All images should therefore be regularly transferred to a safe mass storage medium, e.g. the hard disk of a computer.
- A simple formatting process will initially not irretrievably destroy existing data on the card. Only the directory will be deleted, which means the data will no longer be directly accessible. Data access can be restored with appropriate software. Only data that is overwritten when new data is saved will actually be irretrievable.
- A memory card should be formatted again in the camera if it was formatted in another device, e.g. a computer.
- Contact your retailer or Leica Customer Care for assistance if the memory card cannot be formatted/overwritten (see p. 146).

DATA TRANSFER

Data can be conveniently transferred to mobile devices via Leica FOTOS (see p. 120). Alternatively, a card reader can be used for the transfer.

Note

- We recommend using a card reader for the transfer of large files.

USING RAW DATA (DNG)

You will need specific software for editing data in DNG format, e.g. the professional raw data converter Adobe® Photoshop® Lightroom®.

It allows high-quality conversions of stored raw data. It furthermore provides quality-optimized algorithms for digital color processing, delivering exceptionally low-noise photographs with incredible resolution. During editing, you can adjust parameters like gradation, sharpness etc. in retrospect to achieve the best possible image quality.

You will receive a temporary membership for the Adobe Creative Cloud Foto subscription with the purchase of this camera. You will have to register the camera online to take advantage of this membership:

club.leica-camera.com

RESETTING THE CAMERA TO FACTORY SETTINGS

This function allows you to reset all your custom menu settings back to the factory settings. You can optionally exclude the user profiles, WLAN settings, and image numbering from the reset individually.

- ▶ Select **Reset Camera** in the main menu
 - The prompt **Reset camera to basic settings?** appears.
- ▶ Confirm or reject the reset to factory settings (**Yes**) / (**No**)
 - Selecting **No** will cancel the reset and the display will return to the main menu. Confirming with **Yes** will trigger additional prompts regarding the settings you can opt to keep.
- ▶ Confirm or reject keeping the user profiles (**Yes**) / (**No**)
- ▶ Confirm or reject keeping the WLAN settings (confirm **Yes**) / (reject **No**)
- ▶ Confirm or reject keeping the image numbering (**Yes**) / (**No**)
 - The camera will be reset.

Notes

- Date & time, as well as the preferred language will have to be set up again after a reset. Relevant prompts will appear on screen.
- The image file numbering can also be reset separately via the menu item **Image Numbering** (see p. 115).

FIRMWARE UPDATES

Leica is continuously working on the further improvement and optimization of your camera. Since many camera functions are entirely controlled by software, some of these improvements and additions to the functional scope can be installed in retrospect. Leica offers firmware updates at irregular intervals, which you can download from our website.

Leica will notify you of any new updates, once you have registered your camera.

Find out which firmware version is currently installed

- ▶ Select **Camera Information** in the main menu
 - The current firmware version is displayed next to the menu item **Camera Firmware**.

More information about registering, firmware updates and how to download them to your camera, as well as any amendments and additions to this manual can be found in the customer area of our website at: club.leica-camera.com

UPDATING THE CAMERA FIRMWARE

- ▶ Download the latest firmware version
- ▶ Save the download to the memory card
- ▶ Insert the memory card into the camera
- ▶ Switching the camera on
- ▶ Select **Camera Information** in the main menu
- ▶ Select **Camera Firmware**
 - This menu item is available only if a current firmware file is stored on the inserted memory card.
 - A prompt with information about the camera is displayed.
- ▶ Check the version information
- ▶ Select **Yes**
 - The update will start automatically.
 - Once the process has completed successfully, a relevant message will be displayed and the camera will restart.

Notes

- The camera must not be switched off before the update is completed.
- The message **Battery low** will appear if the battery is not sufficiently charged. Please recharge the battery and then repeat the process described above.

LEICA FOTOS

The camera can be controlled remotely using a smartphone/tablet PC. This will require an installation of the Leica FOTOS app on the mobile device.

- ▶ Scan the following QR code with the mobile device



or

- ▶ The app is available from Apple App Store™/Google Play Store™

CONNECTION

FIRST-TIME CONNECTION TO A MOBILE DEVICE

The connection is established via WLAN. A pairing of the camera and the mobile device is required for a first-time connection to a mobile device.

IN THE CAMERA

- ▶ Select **Leica FOTOS** in the main menu
 - The camera will start automatically, once a WLAN network becomes available. The process may take a few minutes to complete.
- ▶ Wait until the QR code appears on the LCD panel

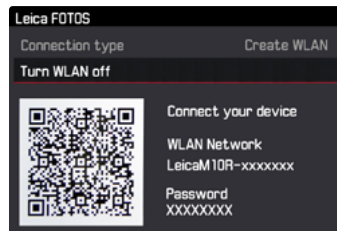

ON THE MOBILE DEVICE

- ▶ Launch the Leica FOTOS app
- ▶ Select the camera model
- ▶ Scan the QR code
 - The process adds the camera to the list of known devices.
- ▶ Follow the Leica FOTOS instructions
 - The relevant icons appear on the LCD panel once a connection is established successfully.

Notes

- The pairing process may take a few minutes to complete.
- Each mobile device only needs to be paired with the camera once. The process adds the device to the list of known devices.

CONNECTING TO KNOWN DEVICES

IN THE CAMERA

- ▶ Select **Leica FOTOS** in the main menu
- ▶ Wait until the QR code appears on the LCD panel

ON THE MOBILE DEVICE

- ▶ Launch the Leica FOTOS app
- ▶ Select the camera model
- ▶ Confirm the prompt
 - The camera connects to the mobile device automatically.

Notes

- Should there be more than one known device in the vicinity of the camera, then it will automatically connect to the first device responding. A favorite mobile device cannot be specified.
- We recommend removing rarely used devices from the list of known devices to prevent unwanted connections.
- Disconnect and reconnect if the wrong device was connected.
- The camera will deactivate the WLAN setting automatically after a few minutes if the app is exited or not used for some time. We do, however, recommend deactivating the WLAN setting manually to optimize battery life.

SHUTTING DOWN THE CONNECTION

It is recommended to shut down the WLAN provided by the camera, once a connection to a mobile device is no longer needed.

- ▶ Select **Leica FOTOS** in the main menu
- ▶ Select **Turn WLAN off**

REMOTE CAMERA CONTROL

You can take pictures remotely via the mobile device, and can also change image settings or transfer data to the mobile device. A list of available functions and instructions for their use can be found in the Leica FOTOS app.

CARE/STORAGE

We recommend the following if the camera will not be used for an extended period of time:

- Switching the camera off
- Remove the memory card
- Remove the battery (after approx. 2 months the set date and time will be lost)

CAMERA HOUSING

- Keep your equipment meticulously clean, as any kind of dirt residue presents a breeding ground for micro organisms.
- Only clean the camera with a soft, dry cloth. Stubborn dirt should first be moistened with a watered-down detergent and can then be wiped away with a dry cloth.
- Wet a soft cloth with tap water, wring it out thoroughly and use it to wipe down the camera. Then wipe it down thoroughly with a dry cloth.
- Wipe the camera with a clean, lint-free cloth to remove stains and fingerprints. Tougher dirt in hard to reach corners of the camera housing can be removed with a small brush. Take care not to touch the shutter blades.
- Store the camera in a closed and padded container to prevent friction damage and protect it against dust accumulation.
- Keep the camera in a dry, sufficiently ventilated place, where it will not be subjected to high temperatures and humidity. Make sure to remove all moisture from the camera if it was used in humid conditions.
- Do not store the camera in a leather case for extended periods of time to prevent fungal contamination.

- Empty your camera bag completely if it ever gets wet during use. Your equipment might otherwise be subjected to moisture and tanning residue released by the moist leather.
- All mechanical bearings and sliding surfaces on your camera are lubricated. Remember to press the shutter button several times every three months to prevent the lubrication points hardening if the camera will not be used for an extended period of time. We also recommend repeated adjustment and use of all the other operating elements.
- When using your camera in tropical climates, make sure to expose the equipment to daylight and fresh air as much as possible to prevent fungal growth. Storage in airtight containers or cases is recommended only in conjunction with a desiccant like silica gel.

LENS

- A soft-bristle brush will usually suffice to remove dust from the outer lenses. Remove more severe soiling with a clean, soft cloth that is completely free of foreign matter. Wipe the lens in a circular motion from the center outward. We recommend using microfiber cloths that come in a protective container and are available from photography shops and other optical retailers. These cloths are machine-washable at 40°C. Do not use fabric softener and do not iron them. Never use spectacle lens cleaning cloths, as these are soaked in chemicals, which could damage the glass of the camera lenses.
- Attach a transparent UVA filter for optimal front lens protection in unfavorable conditions (e.g. sand, salt water spray). Please remember that the filter may create unwanted light reflections in some backlight situations and in case of high contrasts.

- Lens caps also protect the lens against accidental fingerprint smudges and rain.
- All mechanical bearings and sliding surfaces on your lens are lubricated. Make sure to periodically move the focus ring and the aperture setting ring to prevent seizing if the lens will not be used for an extended period of time.
- Make sure not to apply too much lubricant to the bayonet and take particular care not to apply grease to the 6-bit encoding. Too much lubricant will result in grease residue lodging in the gap, where dirt will then accumulate. The legibility of the code will be impacted, which may cause malfunctions in digital M models.

VIEWFINDER/LCD PANEL

- Switch off your camera and leave it to stand at room temperature for around 1 h if condensation has formed on or in the camera. The condensation will disappear, once the camera temperature has reached room temperature.

RECHARGEABLE BATTERY

- Lithium-ion rechargeable batteries should only be stored partially charged, i.e. not fully depleted or fully charged. The camera LCD panel will show the current charge level of the battery. Charge the battery twice a year for around 15 minutes to avoid deep discharge in case of very long storage periods.

MEMORY CARDS

- Make sure to store memory cards in their anti-static container when not in use.
- Do not store memory cards where they will be exposed to high temperatures, direct sunlight, magnetic fields or static electricity. Always remove the memory card if the camera will not be used for an extended period of time.
- We recommend formatting the memory card from time to time, because fragmented residual data from deleted files may block some of its memory capacity.

SENSOR

DUST DETECTION

Any dust or dirt particles stuck to the glass cover of the sensor may result in noticeable dark stains or specks on the pictures. Use the **Dust Detection** function to check if and how much dust is on the sensor. This procedure is more accurate than a visual check and therefore a reliable method to find out if cleaning is needed.

- ▶ Select **Sensor Cleaning** in the main menu.
- ▶ Select **Dust Detection**
 - The following message appears:
Please close the aperture to the largest value (16 or 22), and take a picture of a homogeneous surface (defocussed).
- ▶ Shutter release
 - A “picture” will appear on the LCD panel, in which black pixels represent dust particles.

Note

- A relevant message will be displayed if dust detection is not available. The display will return to the previous screen after a few seconds. Repeat the process as needed.

SENSOR CLEANING

You can send your camera to the Leica Customer Care department for sensor cleaning (see p. 146). This service is not part of the warranty offering and will therefore incur charges. Use the **Open Shutter** menu function if you feel confident that you can do the cleaning yourself. The function will keep the shutter open and allow access to the sensor.

Use clean, possibly ionized gases like air or nitrogen to blow loose dust from the cover glass of the sensor. We recommend using (rubber) bellows without a brush. Some specialist, low-pressure cleaning sprays, e.g. "Tetenal Antidust Professional" can also be used (follow the instructions provided for the product). Please contact Leica Customer Care if you are unable to remove the particles with the methods described above.

Note

- Leica Camera AG will not accept any responsibility for damages caused by the user when cleaning the sensor.

- ▶ Select **Sensor Cleaning** in the main menu.
- ▶ Select **Open Shutter**
 - The Message **Inspect sensor?** appears.
- ▶ Select **Yes/No**
 - The rechargeable battery must have at least 60 % remaining capacity for the shutter to open.
 - A warning message **Battery too low for sensor cleaning** will appear if the battery capacity is lower to indicate that the function is currently not available and **Yes** cannot be selected.
- ▶ Clean the sensor
 - Make sure you follow the instructions below.
- ▶ Switch off the camera after you finish cleaning
 - The following message appears:
Please stop sensor cleaning immediately
 - The shutter will remain open for another 10 s.

Important

- Any inspection or cleaning of the sensor should be done in an environment that is as much as possible dust-free to prevent further contamination.
- A message will appear on the LCD panel, once the capacity of the rechargeable battery falls below 40% with the shutter fully open: **Please stop sensor cleaning immediately**. The shutter will automatically close when the camera is switched off.
- Make sure that the aperture is unobstructed and that nothing can prevent the shutter from closing correctly, as this would result in damage to the equipment!
- Do not attempt to physically blow dust particles off the cover glass of the sensor. The smallest droplets of saliva can cause stains that will be difficult to remove.
- Do not use high pressure compressed air cleaners as they may also cause damage.
- Avoid touching the sensor surface with any hard objects during inspection and cleaning.

FAQ

Problem	possible cause to be verified	Troubleshooting suggestions
Battery issues		
Battery is depleted too quickly	Battery too cold	Warm the battery (e.g. in pants pocket) and only insert directly before use
	Battery too hot	Allow battery to cool down
	LCD panel or EVF set too bright	Reduce brightness
	Power save mode deactivated	Activate Auto Power Saving
	Permanent WLAN connection	Deactivate WLAN when not in use
	Continuous use of LCD panel (e.g. in Live View mode)	Deactivate the function
	Battery has been recharged too many times	The battery has reached the end of its operating time Replace battery
	Preview of the recorded images (Auto Review) activated	Deactivate the function
Charging process not starting	Incorrect battery polarization or faulty charger connection	Check polarization and connection
Charging takes too long	Battery too hot or too cold	Charge the battery at room temperature
Charging pilot light is on, but battery isn't charging	The battery contacts are dirty	Clean the contacts with a soft, dry cloth
	Battery has been recharged too many times	The battery has reached the end of its operating time Replace battery
Camera problems		
The camera suddenly switches itself off	Battery is depleted	Charge or replace the battery
The camera won't switch on	Battery is depleted	Charge or replace the battery
	Battery too cold	Warm the battery (e.g. in pants pocket)
	Battery was inserted incorrectly	Check its polarization
	Bottom cover was inserted incorrectly	Check the directionality and lock
The camera switches off again immediately after it is switched on	Battery is depleted	Charge or replace the battery
Camera does not recognize the memory card	The memory card is not compatible or defective	Replace the memory card
	Memory card is incorrectly formatted	Format the memory card in the camera
Menus and displays		
Electronic viewfinder is dark	EVF brightness is set too low	Set the EVF brightness
Display language is not English	-	Select English in the Language menu

The LCD panel is too dark or too bright/not clear	The brightness setting is incorrect	Adjust the display brightness
	Viewing angle is too small	View it at a perpendicular angle
	Brightness sensor blocked	Make sure that the brightness sensor is not blocked
Favorites menu does not appear	The favorites menu is empty	Add at least one function
Live View stops suddenly or doesn't start	The camera is hot due to high ambient temperature, extended Live View operation, extended video recording or serial exposures	Allow camera to cool down
The brightness in Live View mode is not the same as in the pictures	The brightness settings for the LCD panel have no influence over the exposures	Adjust the brightness settings as needed
	Exposure Simulation is deactivated	Activate the function
The number of remaining exposures does not count down after a picture is taken	The exposure requires only very little memory space	This is not a fault; the number of remaining exposures is calculated as approximations
Recording		
The camera won't take a picture/shutter button is deactivated	Memory card is full	Replace the memory card
	The memory card is not formatted	Reformat the memory card (Caution: Loss of data!)
	The memory card is write protected	Deactivate the write protection on the memory card (small lever on the side of the memory card)
	Dirt on the memory card contacts	Clean the contacts with a soft cotton or linen cloth
	The memory card is damaged	Replace the memory card
	The sensor is overheating	Allow camera to cool down
	The camera has switched off automatically (Auto Power Saving)	Switch the camera on again deactivate auto shutdown as needed
	Picture data is being written to the memory card and the cache is full	Wait
	Noise reduction function is working (e.g. after night photography with long exposure times)	Wait or deactivate noise reduction
	Battery is depleted	Charge or replace the battery
	Camera is processing a picture	Wait
Image numbering has reached its limit.	See section "Data Management"	
Image noise appears on the LCD panel/in the viewfinder when the shutter button is pressed to the first pressure point	The gain is increased to aid image composition if the object is insufficiently lit with reduced aperture opening	Not a fault - picture quality will not be impacted
LCD panel/viewfinder deactivates after a very short time	Power Save settings are activated	Change the settings as needed

The display switches off after the picture is taken/ the LCD panel goes dark after the picture is taken	Flash loads after picture is taken, LCD panel deactivates during load time	Wait until the flash is loaded
Flash won't fire	The flash cannot be used with the current settings	Refer to the list of flash function-compatible settings
	Battery is depleted	Charge or replace the battery
	Pressing the shutter button while flash is still loading	Wait until the flash is loaded
	Automatic bracketing or Picture series is activated	Change the setting
The flash does not fully illuminate the object	Object is outside the flash range	Move object into flash range
	Flash is covered	Make sure the th flash unit is not covered by your finger or some object
No continuous recording available	The camera is overheated and the function was temporarily disabled to protect the camera	Allow camera to cool down
The image on the LCD panel displays lots of noise	Light enhancement function of the LCD panel in dark surroundings	Not a fault – picture quality will not be impacted
Image storage takes a long time	The memory card inserted is slow	Use a suitable memory card
Electronic viewfinder is dark	Switchover between EVF and LCD incorrectly set	Select a suitable setting
Review and image management		
Selected images cannot be deleted	Some of the selected images are write protected	Remove write protection (using the device with which the file was originally set to write protected)
File numbering does not start at 1	The memory card contains previously stored images	See section "Data Management"
The time and date settings are incorrect or are not displayed	The camera has not been in use for an extended period of time (the battery was removed)	Insert a charged battery and configure the correct settings
The time and date stamp on images are incorrect	Time settings are incorrect	Set the time correctly Caution: Time settings will be lost if the camera is not used/remains in storage with a depleted battery over an extended period of time
The time and date stamp on images are unwanted	Setting was ignored	Cannot be removed in retrospect Deactivate the function as needed
Lens information is not displayed	Lens Detection is deactivated	Change the setting
	The attached lens is not encoded	Contact Leica Customer Care
Pictures/recordings are damaged or missing	The memory card was removed while the readiness indicator was flashing	Never remove the memory card while the readiness indicator is flashing. Charge the battery.
	The memory card formatting is faulty or the card is damaged	Reformat the memory card (Caution: Loss of data!)

The most recent recording is not displayed on the LCD panel	Preview is deactivated	Activate Auto Review
Picture quality		
The picture is too bright	Light sensor was covered while picture was taken	Make sure that the light sensor is not obstructed
Image noise	Long exposure times (>1 s)	Activate the noise suppression function for long-term exposure times
	ISO sensitivity set too high	Decrease ISO sensitivity
Round white stains, similar to soap bubbles	Flash photography in very dark environment: reflections of dust particles	Deactivate the flash
Images are out of focus	Lens is dirty	Clean the lens
	Camera moved during exposure	Flash, modes
		Mount the camera on a tripod
	Use shorter shutter speeds	
	The desired subject elements were not congruent in the viewfinder	Ensure perfect congruence of the superimposed images in the split image rangefinder
Images are overexposed	Flash is activated in bright surroundings	Change the flash mode
	Strong light source in the image	Avoid strong light sources in picture composition
	(Half) backlight falling into the lens (also from light sources outside the image range)	Use the lens hood or change to another object
	Selected exposure time is too long	Select a shorter exposure time or turn the shutter speed setting dial to A
The image is grainy or there is image noise	ISO sensitivity set too high	Decrease ISO sensitivity
Unnatural colors and brightness	Picture taken in artificial light or extreme brightness	Try shorter shutter speeds
No images are displayed	No memory card inserted	Insert the memory card
	The recordings were taken with another camera	Transfer the recordings to another device to view them
	The file is in video format	Use another device for playback
Images cannot be displayed	File name of the image was changed on a PC	Use appropriate software for image transfers from a PC to the camera

Smartphones/WLAN		
WLAN connection gets interrupted	Camera deactivates when it overheats (safety feature)	Allow camera to cool down
Cannot pair with a mobile device	The camera was already paired with the mobile device	Delete the camera registration from the Bluetooth settings in the mobile device and repeat pairing process
Mobile device connection/image transfer not working	The mobile device is too far away	Bring the devices closer to each other
	Interference from other devices in the vicinity, e.g. other smartphones or a microwave oven	Increase distance to interfering devices
	Interference from multiple mobile devices in the vicinity	Re-establish the connection/remove other mobile devices
Camera does not appear on the WLAN configuration screen of the mobile device	Mobile device is currently connected to another device	Check connection
	Mobile device does not recognize camera	Switch the WLAN function of the mobile device off and on again

MENU OVERVIEW

Main menu	1. Submenu	Factory settings FAVORITES	Available for FAVORITES	Page
Menu page 1				
Lens Detection			●	38
Drive Mode		●	●	64
	Interval			85
	Exposure Bracketing			86
Exp. Metering			●	77
Exp. Compensation		●	●	83
Flash Settings		●	●	
	Flash Sync. Mode			95
	Max. Flash Sync. Time			96
	Flash Exposure Compensation			96
ISO Setup		●	●	
	M-ISO		●	72
	Maximum Auto ISO			73
	Maximum Exposure Time			73
White Balance		●	●	74
File Format		●	●	62

		Factory settings FAVORITES	Available for FAVORITES	Page
Menu page 2				
JPG Settings		●	●	
	JPG Resolution		●	63
	Contrast			63
	Sharpness			63
	Saturation			63
	Monochrome			63
Auto Review			●	111
Capture Assistants			●	
	Focus Peaking			69
	Histogram			91
	Exposure Clipping			89
	Grids			91
	Exposure Simulation			81
	Focus Aid			71
	Level Gauge			90
EVF/Display Control			●	
	Play Screen Target			60
	LV Screen Target			60
	Auto Review Screen Target			60

		Factory settings FAVORITES	Available for FAVORITES	Page
User Profiles			●	
	Load Profile		●	113
	Save as User Profile			112
	Rename User Profile			112
	Export to Card			113
	Import from Card			113
Customize Control			●	
	Edit Favorites			54
	Customize Wheel			55
	LED			58
Display Brightness			●	59
EVF Brightness			●	59
Menu page 3				
Auto Power Saving			●	57
Leica FOTOS		●	●	120
GPS ¹			●	116
Date & Time			●	
	Auto GPS Time ¹			56
	Time Zone			57
	Daylight Saving Time			57
	Date Setting			56
	Time Setting			56

		Factory settings FAVORITES	Available for FAVORITES	Page
Language			●	56
Reset Camera			●	118
Format SD			●	117
Image Numbering			●	
	New Folder			115
	Change Filename			115
	Reset Image Numbering			115
Menu page 4				
Sensor Cleaning			●	
	Open Shutter			124
	Dust Detection			124
Camera Information			●	
	Camera Firmware			119
	Regulatory Information			5
	Copyright Information			116

¹ This menu item is only available if the Leica Visoflex viewfinder is attached (available as an accessory).

INDEX

A

A (Aperture priority)	78
Accessory	3
Adapter	36
AE-L	82
Akademie, Leica	146
Aperture	77
Aperture priority	78
App	120
Assist function	69
Auto ISO	44, 73
Automatic review	111

B

Basic Picture Settings	62
Basic settings, camera	56
B function	80
Brightness, LCD panel	59
Brightness, rangefinder	59

C

Camera Information	119
Care	122
Carry strap	10, 28
Center button	45
Center-weighted metering	76
Charger	10, 28
Charge status, charger	29
Charge status, LCD panel	27

Charging the battery	29
Clipping	89, 102
Color Saturation	63
Color Temperature	76
Connection, mobile devices	120
Contact, Leica	146
Contrast, Image Properties	63
Copyright	116
Customer service	146

D

Data management	114
Data structure	114
Data transfer	118
Date	53, 56
Deletion, recordings	107
Deletion, user profiles	112
Direct access	55
Directional pad	45
Display, settings	58
Disposal	6
DNG	62, 118
Drive Mode	64, 84, 85

E

EVF	60
Exposure	76
Exposure bracketing	86
Exposure compensation	83
Exposure compensation, flash	96
Exposure, long-term	80
Exposure, manual	79

Exposure metering, flash	93	Folder structure	114
Exposure, metering methods	76	Format	62
Exposure, modes	77	Formatting, memory card	117
Exposure preview	81		
Exposure simulation	81	G	
Exposure time, max.	80	General information	12
		GPS	4, 56
F		Gray Card	75
Factory settings	118	Grid	91
FAQ	126		
Favorites	133, 134, 135	H	
Favorites, menu	48, 54	HDR	86
Favorites, pictures	106	Histogram	91
File Format	62	Horizon	90
File name	115	HSS	94
Firing point, flash	95		
Firmware	14, 119	I	
Fixed ISO value	44, 72	Image Field	65
Flash	92	Image numbering	114
Flash, control	95	Image numbering, reset	115
Flash, exposure compensation	96	Image Properties	63
Flash, exposure metering	93	Information display	88
Flash, firing point	95	Information, regulatory	5
Flash, range	96	Inserting/removing the battery	30
Flash, setting	94	Interval shooting	85
Flash, synchronization	95	ISO Sensitivity	44, 72
Flash units, compatible	92	ISO value, greatest	73
Focus button	45, 70		
Focusing	68	J	
Focus metering methods, via rangefinder	68	JPG Settings	62
Focus peaking	69		
Folders	114		

K		
Keyboard	51	
L		
Language	56	
LCD panel.....	25, 46, 58, 60	
LCD panel, setting.....	58	
LED	58	
Legal information	4	
Leica Academy.....	146	
Leica Customer Care.....	146	
Leica FOTOS	7, 120	
Lens	9, 33, 122	
Level Gauge	90	
Light balance	79	
Live View	67, 69, 77	
Long-term exposure	80	
M		
Magnification, assist function	70	
Magnification, Review mode	103	
Magnifying glass	70	
Main menu.....	49	
Main switch	42	
Manual exposure setting	79	
Maximum Exposure Time	80	
Memory card	10, 13, 31, 117, 123	
MENU button	46	
Menu control	48	
Menu language	56	
Menu navigation.....	50	
Menu screen.....	48	
Metering memory lock	82	
Metering method, exposure.....	76	
M (Manual exposure setting)	79	
Monochrome Photography	63	
Multi-field metering, exposure	76	
N		
Name, file	114, 115	
Name, folder	114	
Navigation, menu	50	
Noise reduction	80	
Notes, legal.....	4	
Number pad.....	51	
O		
Operating mode, exposure	77	
P		
Parts, overview	20	
Picture, interval.....	85	
Picture Mode	64	
Picture series.....	84, 85, 86	
PLAY button	46	
Power off, automatic	57	
Power save mode.....	57	
Preview	111	
Problems	126	
Profile, user	112	

Q	
Quick access	54
R	
Rangefinder	65, 77
Rating, recording.....	106
Raw data.....	118
Rechargeable battery, capacity.....	27
Rechargeable battery, notes	9, 12, 123
Recording, delete	107
Recording, marking.....	106
Recording, rating.....	106
Regulatory information	5
Remote control	121
Repair	146
Replacement parts.....	3
Reset, camera.....	118
Reset, image numbering.....	115
Resolution.....	62
Review, automatic.....	111
Review mode	100
S	
Safety remarks.....	8
Saturation, Image Properties	63
Saving, energy	57
Scale	52
Scope of delivery	2
SD card	10, 13, 31, 117, 123
Self-timer.....	87
Sensitivity, ISO.....	44, 72
Sensor.....	10, 14, 124
Sensor cleaning	124
Serial exposures	84
Service	146
Settings, store.....	112
Sharpness, Image Properties.....	63
Shutter button.....	43
Shutter release	43
Shutter speed/aperture combination	77
Shutter speed setting dial.....	44
Smartphone.....	120
Split image method	68
Spot metering, exposure	76
Standby mode.....	57
Status LED.....	58
Status screen.....	55
Storage.....	122
Submenu	49
Superimposed image method	68
Switching, mode	101
Switching on/off, camera	42
Sync point	95
T	
Tagging, recordings	106
Technical Data	142
T function	80
Thumbwheel	45
Time	53, 56
Time lapse	85
Time zone	57
Touch control.....	47
Transfer, data	118

Troubleshooting	126
TTL metering.....	92, 93

U

Update, firmware	14, 119
User-defined operation.....	54
User profiles	112

V

Viewfinder.....	24
-----------------	----

W

Warranty	15
White Balance	74
Wi-Fi/WLAN	7

TECHNICAL DATA

CAMERA

Designation

Leica M10-R

Camera type

Digital camera with rangefinder system

Type no.

6376

Order No.

20 002 black chromed/ 20 003 silver chromed

Buffer memory

2 GB/10 sequential recordings

Storage medium

SD cards up to 2 GB/SDHC cards up to 32 GB/SDXC cards up to 512 GB

Material

Top cover and bottom cover: brass, black chromed

Front and rear housing panels: magnesium

Lens mount

Leica M bayonet with additional sensor for 6-bit encoding

Compatible lenses

Leica M-lenses, Leica R-lenses via adapter

Operating conditions

0 to +40 °C

Interfaces

ISO accessory shoe with additional control contacts for Leica flash units and Leica Visoflex viewfinder (optional accessory)

Tripod thread

A 1/4 DIN 4503 (1/4") with stainless steel in the base

Dimensions (W x H x D)

139 x 38.5 x 80 mm

Weight

approx. 675 g (with battery)

SENSOR

Sensor size

CMOS chip, active surface approx. 24 x 36 mm

Processor

Leica Maestro II

File formats

DNG™ (raw data, loss-free compression), JPG

Resolution

DNG™: 7864 x 5200 pixels (40.89 MP)

JPG: 7840 x 5184 pixels (40.64 MP), 5472 x 3648 pixels (20 MP),

2976 x 1984 pixels (6 MP)

File size

DNG™: 40-60 MB

JPG (40 MP): 10-20 MB (depending on resolution and image content)

Color depth

DNG™: 14 bit

JPG: 8 bit

Color space

sRGB

RANGEFINDER/LCD PANEL

Design principle

Large, bright-line rangefinder with automatic parallax compensation

Eyepiece

Suitable for -0,5 dpt; optional corrective lenses available: -3 to +3 dpt

Display

Four-digit digital display with items show on the top and bottom
Image field limiter: two lit frames: 35 mm + 135 mm, 28 mm + 90 mm,
50 mm + 75 mm (automatic switchover when lens is attached)

Parallax compensation

The horizontal and vertical difference between viewfinder and lens is compensated automatically in line with the relevant focus setting.
Congruence of viewfinder and actual image.

The size of the bright-line frame matches the distance:

- at 2 m: the exact sensor size of approx. 23.9 x 35.8 mm
- at infinity: (depending on focal length) approx. 7.3% (28 mm) to 18% (135 mm)
- less than 2 m: less than sensor size

Magnification

x0.73 (all lenses)

Large-base rangefinder

Split or superimposed image rangefinder shown as a bright field at the center of the viewfinder image

Actual metering basis

50.6 mm: 69.31 mm (mechanical metering basis) x x0.73 (viewfinder magnification)

LCD panel

3" TFT LCD, 1,036,800 dots, touch control available

SHUTTER

Shutter Type

Metal blade focal plane shutter with vertical movement

Shutter speeds

With aperture priority set: (A) continuous between 16 min and 1/4000 s, with manual setting: between 8 s and 1/4000 s in half increments, between 8 s and 16 min in full increments, B: for long exposures up to 16 min (in conjunction with self-timer T function, i.e. 1. shutter release = aperture opens, 2. shutter release = aperture closes), (1/180 s): shortest shutter time for flash synchronization, HSS linear flash mode with all shutter speeds below 1/180s available (with HSS-compatible Leica system flash units)

Shutter button

Two-step (1. step: Activation of the camera electronics including exposure metering and metering memory lock (in aperture priority mode); 2. step: firing)

Self-timer

Delay time: 2 s or 12 s

Drive Mode

Single

Continuous Low Speed approx. 3 fps

Continuous High Speed approx. 4.5 fps

Interval

Exposure Bracketing

FOCUSING

Working range

70 cm to infinity

Focus Mode

Manual: (focus assist functions Magnification and Focus Peaking available)

EXPOSURE**Exposure metering**

TTL (exposure metering through the lens), with working aperture

Metering principle/method

When measuring the light reflected by the light blades of the 1. shutter curtain onto a measuring cell: strongly center-weighted; when measuring on the sensor: Spot metering, center-weighted measurement, multi-field metering

Exposure modes

Aperture priority mode (A): automatic shutter speed control with manual aperture preselection

Manual (M): manual setting for shutter speed and aperture

Measuring range

At room temperature and normal humidity for ISO 200 at aperture 1.0

EV -1 to EV 19 at aperture 32

Flashing of the left triangular LED in the viewfinder indicates values below the measuring range

Exposure Compensation

± 3 EV in 1/3 EV increments

Automatic bracketing

3 or 5 exposures, up to ±3 EV, in 1/3 EV increments

ISO sensitivity range

ISO Auto: ISO 100 to ISO 50000

Manual: ISO 100 to ISO 50000

White balance

Automatic (**Auto**), presets (**Daylight**, **Cloudy**, **Shadow**, **Tungsten**, **HMI**, **Fluorescent Warm**, **Fluorescent Cool**, **Flash**), one memory slot for manual measurements (**Gray Card**), manual color temperature setting

FLASH EXPOSURE CONTROL**Flash unit connector**

Via accessory shoe with central and control contacts

Synchronization

Optionally at the 1. or 2. shutter curtain

Flash sync time

⚡ : 1/180 s, slower shutter speeds available, automatic switchover to TTL linear flash mode with HSS-compatible Leica system flash units if sync time is undercut

Flash exposure metering

Using center-weighted TTL pre-flash metering with Leica flash units (SF 40, SF 64, SF 26), or flash units compatible with the system with SCA3502 M5 adapter

Flash measuring cell

2 silicon photodiodes with converging lens in the base of the camera

Flash exposure compensation

±3 EV in 1/3 EV increments

Displays in flash mode (in the viewfinder only)

Flash Exposure Compensation via the flash icon LED

EQUIPMENT**WLAN**

WLAN function for connecting to the Leica FOTOS app. The Leica app is available from the Apple App Store™ or the Google Play Store™.

Complies with the IEEE 802.11b/g/n standard (default WLAN protocol), channel 1-11, encryption method: WLAN-compatible WPA™/WPA2™, access method: infrastructure mode

GPS

Only with Leica Visoflex viewfinder attached (optional accessory)
Optional, not available everywhere due to country-specific legislation.
Data is written to Exif header of the picture files

Menu languages

English, German, French, Italian, Spanish, Russian, Japanese, Simplified Chinese, Traditional Chinese, Korean, Portuguese

POWER SUPPLY**Rechargeable battery (Leica BP-SCL5)**

1 lithium-ion battery, rated voltage 7.4 V; capacity 1100 mAh, max. charging voltage/current: 1000 mADC, 7.4 V; operating conditions (in the camera): +0 to +40°C; manufacturer: PT. VARTA Microbattery, Made in Indonesia

Charger (Leica BC-SCL5)

Inputs: alternating current 100-240 V, 50/60 Hz, 300 mA with automatic switch-over or direct current 12 V, 1.3 A; Output: DC, rated voltage 7.4 V, 1000 mA / max. 8.25 V, 1100 mA; Operating conditions: +10 to +35°C; Manufacturer: Guangdong PISEN Electronics Co. Ltd., Made in China

LEICA CUSTOMER CARE

Please contact the Customer Care department of Leica Camera AG for the maintenance of your Leica equipment and for help and advice regarding Leica products and how to order them. You can also contact the Customer Care department or the repair service provided by your regional Leica subsidiary for repairs or warranty claims.

Leica Camera AG

Leica Customer Care
Am Leitz-Park 5
35578 Wetzlar
Germany

Phone: +49 (0)6441 2080-189

Fax: +49 (0)6441 2080-339

Email: customer.care@leica-camera.com

www.leica-camera.com

LEICA AKADEMIE

Have a look at our full seminar program with many interesting workshops on the topic of photography at:
us.leica-camera.com/Leica-Akademie/Global-Leica-Akademie